



**OFFICIAL MINUTES OF THE OXFORD MAYOR AND COUNCIL MEETING  
WORK SESSION  
MONDAY, April 15, 2019 – 6:00 PM  
CITY HALL**

**MEMBERS PRESENT: Mayor Jerry D. Roseberry; Councilmembers: Jim Windham, Jeff Wearing, Sarah Davis George Holt, David Eady, and Mike Ready.**

**OTHERS PRESENT: Matt Pepper, City Manager; Dave Harvey, Police Chief; Connie Middlebrooks, City Clerk; Jody Reid, Utility Superintendent; Hoyt Oliver, Michael McQuaide, Art and Laurie Vinson, Laura Gafnea, from Oxford College; Angela Pilgrim, Cheryl Ready, Juanita Carson, Hoyt Oliver, Judy Greer, Peggy Madden, Gwen Green, and Christine Carling from ECG.**

The meeting was called to order by Mayor Jerry D. Roseberry.

**Agenda** (Attachment A)

**1. Mayor's Announcements**

Mayor Roseberry began the meeting by informing those in attendance of the Oxford Lions Club annual yard sale on May 4<sup>th</sup> from 8 a.m. until 1 p.m. The yard sale will be held on the City Greenspace at the corner of Emory Street and West Clark Street. Profits from the yard sale will be used for community and sight service projects. Mayor Roseberry also announced GMA's District Five Spring meeting will be held April 25<sup>th</sup> from 6 p.m. until 8 p.m. at the City of Jefferson Civic Center in Jefferson Georgia. The Mayor shared details from the Service Delivery Strategy meeting which was held April 2<sup>nd</sup> at the old Historical Courthouse. Mayor Roseberry provided a police report for the Month of March which consisted of 90 citations, 74 warnings, and 15 arrest.

**2. State-wide Pole Attachment Agreements**

Christine Carling from ECG addressed Council on the contract negotiations on behalf of the City of Oxford with Verizon Wireless and Cingular Wireless. Ms. Carling touched on the terms of the contracts regarding fees, some demands of both Verizon and Cingular to be able to place more antennas and wireless equipment on poles in order to improve customer internet/wireless access and use of City Rights-Of-Way. Mayor Roseberry requested that Ms. Carling also review the contracts with AT&T to see how the city can go about eliminating some of the double poles along city rights-of way. Ms. Carling will work with Matt to draft a Right -Of -Way permitting ordinance. (Attachment B)

**3. Asbury Street Park**

Ms. Cheryl Ready, representing the Asbury Street Park Citizens Advisory Committee, addressed Council regarding suggestions for naming the park upon completion. The committee would like to ensure that all the families with ties to that area receive some type of recognition. Councilmember Windham suggested placing a



plaque at the park detailing the families and their affiliation to the property. Mayor Roseberry suggested that the committee consider accepting citizen recommendations as well.

#### **4. 107 W. Clark Street renovation Project**

Councilmember Wearing informed the Council that the Yarbrough House Renovation Committee met last week with Jordan Shoemaker from the Northeast Georgia Regional Commission, however they are still waiting for those recommendations. Mayor Roseberry requested that the committee ensure that they recognized the Yarbrough House as a historical building on a historical site and it not be considered commercial property.

#### **5. Emory Street Sidewalk Project**

Georgia Department of Transportation has granted permission to move forward with advertising for bids for the project. The sidewalk will span from Moore Street to Geiger Street. Councilmember Eady suggested that we have Oxford College reaffirm their commitment to complete the sidewalk from Moore Street to Pierce Street after concerns raised by Councilmember Windham of having sidewalks that lead to nowhere all through the city. The City of Oxford will be responsible for 26% of the cost for the project with \$130,000 considered for the sidewalk and \$41,000 considered for the engineering of the project. This item moved to the May 6<sup>th</sup> Regular Session for a vote.

#### **6. FY2020 Operating Budget (Attachment C)**

Councilmember Ready recommended that the city would maintain current millage rate of (6.22 mills) and will not be accepting the rollback. In addition, he reported that the FY2020 budget would see an increase in LOST revenue to account for steady county-wide sales tax growth as well as an increase to Interest Revenue due to interest accruing in Georgia Fund One. Councilmember Ready stated that the budget committee would be recommending a decrease in the funds allocated to the Yarbrough House Welcome Center. The committee would suggest new line items to accommodate for upgrades to the existing telephone equipment (\$8,000), upgrades to the security system to include the maintenance facility and Asbury Park and replacements to the current firewall and server at City Hall (\$16,650). The committee also requested that Council consider creating another groundskeeper position in order to help maintain the park. Councilmember Ready informed Council that the Newton County Water & Sewerage Authority would not increase the wholesale water rates and in turn the city would not impose a rate increase to our water and sewer customers. (Attachment C)

#### **7. FY2020 Capital Budget**

Councilmember Holt addressed the FY2020 Capital improvement plan. He highlighted changes in the budget for the E. Clark Street Development, Electric Systems Improvements, and the Yarbrough House Renovation/Welcome Center. New items to be considered in the budget were a new backhoe tractor for the Water & Sewer Department, new lawn mower for the Streets Department, and an RTV for Streets/Parks & Recreation Department. Councilmember Ready requested to know from which budget would the proposed welcome sign for the greenspace at Emory and Geiger Street be allocated. Councilmember Holt suggested that a line item be created under the capital budget to accommodate that proposed project. (Attachment D)

#### **8. Electric System Improvements**

Utility Superintendent Jody Reid addressed Council on projected plans to replace equipment, wires switches, and poles along West Clark Street, Longstreet Circle, Oxford North Road, and Williams Street. Mr. Reid recommended Council accept the bid from Over and Under Contractors, Inc. at \$91,601.40 to complete the work and the bid from Gresco at \$32,322.15 for all material associated with the project. (Attachment E)



**9. City Pollinator Garden**

Councilmember Windham informed the Council that he had met with Satsuki Garden Club President, Connie Waller and her Husband David, to get their recommendations for the Pollinator Gardens. Councilmember Windham invited anyone interested to join them on Thursday April 25th to travel to the suggested locations for the gardens.

**10. Other Business**

Councilmember Windham requested suggestions on how to eliminate the fishing and swimming taking place at the pond owned by the city and Councilmember Wearing. Mayor Roseberry suggested making sure the property was properly posted. Council requested Chief Harvey to research options and to start to patrol that area more frequently. Council was also asked to go ahead and approve the immediate replacement of the firewall for City Hall computer systems. The consensus was unanimous to move forward with the firewall replacement.

Meeting Adjourned at 7:27 pm.

Respectfully Submitted,



Connie D. Middlebrooks  
City Clerk



ATTACHMENT A

**OXFORD MAYOR AND COUNCIL  
WORK SESSION  
MONDAY, APRIL 15, 2019 – 6:00 P.M.  
CITY HALL  
A G E N D A**

1. **Mayor's Announcements**
2. \* **State-wide Pole Attachment Agreements** – Christine Carling with ECG will discuss with Council the new Pole Attachment License Agreements for Distribution Poles for both Verizon Wireless and New Cingular Wireless. We have attached the agreements for New Cingular and Verizon.
3. **Asbury Street Park** – Members of the Asbury Street Park Citizens Advisory Committee will share their recommendations for the park's name with Council.
4. **107 W. Clark Street Renovation Project** – The ad hoc Yarbrough House Renovation Committee will report on the progress of the 107 W. Clark Street Renovation Project.
5. **Emory Street Sidewalk Project** – Staff will report on the progress of the Emory Street Sidewalk Project. The Georgia Department of Transportation has granted permission for the city to move forward with advertising for the project. Before advertising, the city will need to consider contracting with a third-party engineering firm to provide construction administration and materials testing services for the project.
6. \* **FY2020 Operating Budget** – The ad hoc operating budget committee (Councilmembers Ready, chair, Wearing, and Davis) will report on the draft of the operating budget for FY2020 (July 2019 – June 2020). A DRAFT copy is attached.
7. \* **FY2020 Capital Budget** – The ad hoc capital budget committee (Councilmembers Holt, chair, Eady, and Windham) will report on the draft of the five-year capital budget for FY2020 – FY2024 (July 2020 – June 2024). A DRAFT copy is attached.
8. \* **Electric System Improvements** – The FY2019 Capital Budget includes \$160,000 for a project to replace equipment, wires, switches, and poles along Williams Street, Oxford North Road, W. Clark Street, and a section of Longstreet Circle. We recommend that Council award the purchase order to Over and Under Contractors, Inc. at \$91,601.40 to complete the work and Gresco at \$32,322.15 for all materials associated with the project. We have attached the quotes.
9. **City Pollinator Garden** – Councilmember Windham requested that Council discuss planting pollinator gardens in sections of the city's right-of-way.

\*Attachments





**POLE ATTACHMENT LICENSE AGREEMENT  
FOR DISTRIBUTION POLES**

**BETWEEN**

**City of Oxford**

**AND**

**NEW CINGULAR WIRELESS PCS, LLC**

**TABLE OF CONTENTS**

PREAMBLE ..... 3

ARTICLE 1 – SCOPE OF AGREEMENT ..... 3

ARTICLE 2 – EXPLANATION OF TERMS ..... 3

ARTICLE 3 – SPECIFICATIONS ..... 7

ARTICLE 4 – ESTABLISHING ATTACHMENTS TO POLES ..... 7

ARTICLE 5 – RADIO FREQUENCY ..... 11

ARTICLE 6 – RIGHT OF WAY FOR LICENSEE'S ATTACHMENTS ..... 12

ARTICLE 7 – MAINTENANCE OF POLES AND ATTACHMENTS ..... 12

ARTICLE 8 – DIVISION OF COSTS ..... 13

ARTICLE 9 – INSPECTIONS ..... 15

ARTICLE 10 – UNAUTHORIZED ATTACHMENTS ..... 16

ARTICLE 11 – ATTACHMENT COUNTS ..... 17

ARTICLE 12 – ABANDONMENT OF LICENSED POLES ..... 17

ARTICLE 13 – POLE ATTACHMENT RENTAL FEES ..... 18

ARTICLE 14 – DEFAULTS ..... 18

ARTICLE 15 – RIGHTS OF OTHER PARTIES ..... 19

ARTICLE 16 – ASSIGNMENT OF RIGHTS ..... 19

ARTICLE 17 – WAIVER OF TERMS OR CONDITIONS ..... 20

ARTICLE 18 – PAYMENT OF TAXES ..... 20

ARTICLE 19 – BILLS AND PAYMENT FOR WORK ..... 20

ARTICLE 20 – NOTICES ..... 21

ARTICLE 21 – RESOLUTION OF CERTAIN DISPUTES ..... 22

ARTICLE 22 – TERM OF AGREEMENT ..... 24

ARTICLE 23 – EXISTING CONTRACTS ..... 25

ARTICLE 24 – LICENSOR SYSTEM FINANCING OR SALE OF SYSTEM ..... 25

ARTICLE 25 – LIABILITY AND INDEMNIFICATION ..... 25

ARTICLE 26 - COMPLIANCE WITH LAWS; CHANGE OF LAW ..... 28

ARTICLE 26 – CONSTRUCTION ..... 28

ARTICLE 27 – REMEDIES CUMULATIVE ..... 28

ARTICLE 28 – MISCELLANEOUS ..... 28

[SEAL] ..... 30

Exhibit 1 – Application to Attach ..... 31

Exhibit 2 – Annual Attachment Fee ..... 33

Exhibit 3 Radio Frequency Emissions Certification ..... 34

Exhibit 4 – Approved Contractors ..... 35

Exhibit 5 – ECG Specifications ..... 36

## ***POLE ATTACHMENT LICENSE AGREEMENT FOR DISTRIBUTION POLES***

### **PREAMBLE**

THIS AGREEMENT (“Agreement”), effective as of this 19th day of March, 2019 (“Effective Date”), by and between the undersigned municipal corporation of the State of Georgia (the “Licensor”), and New Cingular Wireless PCS, LLC, a limited liability company organized under the laws of the State of Delaware (the “Licensee”), referred to collectively as “Parties,” and individually as “Party”;

WHEREAS, the Licensor and Licensee desire to enter into a pole attachment license agreement for the use of Licensor’s poles, erected or to be erected within the area in which both Parties render service in the State of Georgia, to be consistent with the terms of this Agreement.

NOW, THEREFORE, in consideration of the premises and the mutual covenants herein contained and other consideration set forth herein the adequacy of which is acknowledged, the Parties hereto for themselves, their successors and assigns do hereby agree to the following terms and conditions:

### **ARTICLE 1 – SCOPE OF AGREEMENT**

A. This Agreement will be in effect in the area in which both of the Parties render service in the State of Georgia, and will cover all distribution poles now existing or hereafter erected in the above territory when said poles are brought under this Agreement in accordance with the procedure hereinafter provided.

B. Licensor reserves the right for good cause to exclude from use any of its facilities for objective reasons of safety, reliability, capacity, and generally applicable engineering standards.

### **ARTICLE 2 – EXPLANATION OF TERMS**

A. For the purpose of this Agreement, the following terms will have the following meanings:

“Above the Communications Space” means the space above the Communications Space, as defined below, but not limited to the Power Space and space above the Power Space.

“Actual Costs” means all costs, including, but not limited to, the costs of materials, labor, engineering, supervision, overheads, transportation and contractor fees, when used in lieu of Licensor labor. Licensor Actual Costs will be verifiably comparable to the cost Licensor pays for similar work to its own facilities.

“Affiliate” means any entity that controls, is controlled by, or is under common control with Licensee.

“Application” means the process described in Article 4 hereof used by the Licensee to receive Licensor’s permission to install initial facilities, to modify existing facilities, or to add additional facilities outside the Licensee’s allocated twelve inches (12”) of space on Licensor’s poles, as provided herein. The form used for the Application process is identified as Exhibit 1 and is included as a part of this Agreement.

“Attachment” means any wire, line, antenna, radios, cabinets, apparatus or related equipment attached to a Pole, including, but not limited to, brackets, cables, Service Drops, power supplies, amplifiers, pedestals, bonding wires, Overlashings, guy wires and anchors required to support unbalanced loads. A single Attachment includes the vertical space consisting of a total of twelve inches (12”) either above or below, but not both, the bolted Attachment, exclusive of riser or conduit.

“Clearance Space” means the space on the Pole below the point where horizontal wire or horizontal cable equipment may not be installed in accordance with the Specifications. For purposes of this definition, “horizontal” means spanning from Pole to Pole or extending more than three feet (3’) from the surface of the Pole.

“Communications Space” means the space on the pole immediately below the Power Space extending to the lower of the existing lowest horizontal cable attachment, as specified by the National Electrical Safety Code, or reserved space, if applicable.

“Contact Person” is defined in Article 20.

“Cost in Place” means the cost of the bare pole, labor to install the pole and associated overheads, including engineering.

“Effective Date” is defined in the Preamble.

“Licensor” is defined in the Preamble.

“Force Majeure Event” is defined in Article 28.

“Inventory” means an Inventory of Licensee’s Attachments which will confirm the total number of Licensee’s Attachments, a summary of obvious non-conforming Attachments and any pending Licensee Transfers to Licensor poles.

“Interference” for the purposes of this Agreement, may include, but is not limited to, any use on the property or surrounding property that causes electronic or physical obstruction with, or degradation of, the communications signals from the communication facility.

“Joint User” means a person or entity that is currently occupying or reserving space on Licensor’s Poles, and has a right to attach to a Pole or anchor owned, controlled, or otherwise operated by Licensor in return for granting Licensor equivalent rights of Attachment or occupancy to poles and/or anchors, which the Joint User owns.

“Licensed Pole” means a pole for which Licensee has a valid and effective permit to locate and maintain an Attachment to the terms of this Agreement.

“Licensee” is defined in the Preamble.

“Licensee Transfer Date” is defined in Article 7.

“Licensor” is defined in the Preamble.

“Make Ready” means all work necessary or appropriate to make space for or otherwise accommodate new, additional or changed Attachments, including, but not limited to, necessary or appropriate Rearrangements, removal and replacement of the pole, Transfers and other work incident thereto.

“Make Ready Costs” means all costs necessary for Licensor, and other existing parties on the applicable Pole, to prepare the Poles for Licensee’s new, additional or modified Attachments, including, but not limited to, the costs of materials, labor, engineering, supervision, overheads, and tree trimming costs. Engineering includes design, proper conductor spacing and bonding, calculations to determine proper ground clearances and pole down guy and anchor strength requirements for horizontal and transverse loading, and compliance with all applicable requirements. Also included among Make Ready Costs are the costs of installing or changing out primary Poles, secondary Poles and drop and lift poles, including the cost of installation and/or removal of guys, anchors, stub poles, materials and equipment, temporary construction and all other construction in accordance with the technical requirements and specifications as outlined in this Agreement. Licensor Make Ready Costs will be verifiably comparable to the cost Licensor pays for similar Make Ready Work to its own facilities.

“Make Ready Estimate” means the estimate prepared by Licensor for all Make Ready Work that may be required by Licensor to accommodate Attachment(s) by Licensee.

“Make Ready Work” means all work required by Licensor or others attached to the Pole to accommodate Attachment(s) by Licensee.

“NESC” is defined in Article 3.

“Outside Party” or “Third Party” is defined as persons or entities not party to this Agreement.

“Parties” is defined in the Preamble.

“Pole” or “pole” means a wooden, concrete or steel structure owned, controlled, or otherwise operated by Licensor to support distribution lines and related facilities of Licensor, including drop, lift, and light poles, and streetlight poles which do not support distribution lines and related facilities.

“Power Space” means any space on the pole primarily utilized by Licensor for the distribution of electric power, space between power lines, and includes the space from the top of the pole down to the Communications Space and includes the space above the Communications Space designated by the National Electrical Safety Code as the “communication worker safety zone”.

“Rental Fee,” “rental fee,” “Rental” or “rental” means the annual amount per billable Attachment (as defined herein) that Licensee must pay to Licensor pursuant to Article 13 of this Agreement.

“Rearrangement” means the moving of Licensee Attachments, the Licensor’s equipment or a third party’s equipment from one position to another on the same Pole.

“Referee” is defined in Article 21.

“Safety Inspection” means an inspection of Licensor poles to identify and remediate non-conforming Attachments (e.g. NESC violations) and other safety conditions on Licensor poles, performed after the Effective Date.

“Service Drop” means a Licensee wire or other facility used to connect to a Licensee’s customer’s location from a Licensor pole.

“Specifications” is defined in Article 3 hereof.

“Transfer” means the removal of Attachments from one Pole and the placement of such Attachments upon another Pole.

“Unauthorized Attachment” means any affixation of any Licensee Attachment to Licensor Poles, which has not been authorized as required by this Agreement.

“Unauthorized Attachment Fee” means the fee to be paid by Licensee for each Unauthorized Attachment.

B. The following rules of interpretation apply to this Agreement and are by this reference incorporated into this Agreement:

- (1) the word “or” is not exclusive and the words “including” or “include” are not limiting;
- (2) the words “hereby,” “herein,” “hereof,” “hereunder” or other words of similar meaning refer to the entire document in which it is contained;
- (3) a reference to any agreement or other contract includes permitted supplements, amendments and restatements;
- (4) a reference to a law includes any amendment or modification to such law and any rules or regulations promulgated thereunder or any law enacted in substitution or replacement therefore;
- (5) a reference to singular includes plural and vice-versa and each gender includes the other;
- (6) a reference to days, months, or years refers to calendar days, months, and years, unless business days are specified;
- (7) Article and Section headings and table of contents are only for reference and are not to be considered in interpreting this Agreement;

- (8) a reference to an Article, Section, Appendix, Exhibit or Schedule which does not specify a particular document is to the relevant Article, Section, Appendix, Exhibit or Schedule of the document containing the reference;
- (9) a reference to an Article includes all Sections and subsections contained in such Article, and a reference to a Section or subsection includes all subsections of such Section or subsection;
- (10) All terms not otherwise defined herein will have the meaning commonly ascribed thereto in the relevant industry;
- (11) "\$" or "dollars" refers to United States dollars; and
- (12) The word "will" has the same meaning as "shall."

### **ARTICLE 3 – SPECIFICATIONS**

A. The use of the Poles covered by this Agreement will be in conformity with all applicable provision of the following (the "Specifications"): (1) Section 5 "Joint Use and Clearances" of the Electric Cities of Georgia Inc. Construction Assembly Specifications (a copy of which is attached hereto as Schedule 3 and incorporated herein by this reference) as it applies to Licensee's Attachments, and subsequent revisions thereof, provided Licensor has given Licensee sixty (60) days written notice of such revisions; and (2) requirements of the National Electrical Safety Code (2012) of The Institute of Electrical and Electronics Engineers, Incorporated and subsequent revisions thereof ("NESC"). Where there is a disagreement between Specifications, the applicable NESC Specifications will apply. Modifications of, additions to, or construction practices supplementing wholly or in part the requirements of the Specifications will, when accepted in writing by both Parties hereto, likewise govern the Licensee's use of Poles, and when so accepted will be included within the term "Specifications." Any revision to the Specifications will apply on a prospective basis, except as otherwise required by the NESC or any applicable law. No Application is necessary to correct safety violations or comply with applicable Specifications.

B. Each Party will keep its Attachments in safe condition and in thorough repair. Licensee's Attachments will be identified consistent with the Georgia Overhead Marking Standards as adopted by the Georgia Utilities Coordinating Council. Attachments previously in place on Licensor's Poles will be so identified by Licensee as regular or emergency work occurs or at the next system rebuild opportunity, but not later than five (5) years from the Effective Date of this Agreement. Licensee will be responsible for periodically inspecting its Attachments to ensure they have permanent identification markers. After the fifth year, should Licensor encounter any of Licensee's Attachments without permanent identification markers, Licensor may notify Licensee, provided that Licensor can identify the Attachments as belonging to Licensee. If the markers are not placed within sixty (60) days of such notice, then Licensor may install the necessary markers, and Licensee will reimburse Licensor for the cost of such work.

### **ARTICLE 4 – ESTABLISHING ATTACHMENTS TO POLES**

Before Licensee will make use of Licensor's Poles under this Agreement, or modify existing attachments, it will submit an Application, as required herein. The Application will be sent

either (i) by electronic mail with electronic mail "read" receipt obtained, (ii) hand delivery or (iii) by being deposited in the United States mail with proper postage and properly addressed to the person receiving the Application. When transmittal is by hand or U.S. mail, the Licensee will also send an electronic mail message, return receipt requested, to Licensor as notice that the Application was hand-delivered or sent by the U.S. mail.

**A. APPLICATION AND NOTIFICATION PROCEDURE**

1. Except in connection with (i) Pole Transfers, (ii) correcting noncompliance, (iii) removals, (iv) modifications subject subsection (2) below, or (v) any other written Licensor requested action of the Licensee, Licensee must submit to Licensor an Application for any Licensee construction on Licensor Poles (including reconstruction of existing Pole lines) that involves the placement of new or additional Attachments.

2. Subsequent to the original installation of Licensee's Attachments, Licensee may make modifications to or replace Licensee's Attachments, or may alter, enhance, and upgrade its Attachments, so long as such modification, replacement, substitution, alteration, enhancement, or upgrade does not increase pole loading beyond the pole loading that was established in the approved Application or involve placement of Attachment outside the area designated in the approved Application, without obtaining prior written consent of Licensor. Any modification that would involve increasing the pole loading or outside the area designated beyond what was established in the approved Application will require Licensee to submit a new Application for such pole.

3. Licensee will submit a completed Application on the form attached hereto and identified as Appendix A, and all supporting data in accordance with said Application, or such other form as may be mutually agreed upon, specifying fully, to the extent applicable, the information shown on Appendix A.

**Application Fee** – Licensee will be charged in the amount of fifty dollars (\$50) for each Pole submitted under this Agreement. Licensor will keep a cumulative annual total of Application Fees and invoice Licensee for such Application Fees annually, along with the annual Rental Fees. The invoice provided for herein will be paid by the Licensee simultaneously with its payment of the annual Rental Fees. Failure to include all pertinent information relating to the Application set forth in Appendix A will result, at the Licensor's option, in the returning of the Application to Licensee unapproved or holding the Application until the required documentation is received. Licensor will make timely and reasonable efforts to contact Licensee should its Application be incomplete.

**Inspection Fee** – Except for any work required by Licensor, including, but not limited to, Transfers and rearrangements done at the request of Licensor or a third party, road improvement projects, and the installation of new Poles where none currently exist, Licensee will reimburse Licensor for the Actual Costs incurred by Licensor in performing necessary field inspections and preparation of an estimate of the Make Ready Costs of each Pole covered in the Appendix A. The Licensor will provide, as a deliverable for the above inspection fees, a Pole inspection report with appropriate data as the Parties may agree upon. Licensee will reimburse Licensor for such costs within sixty (60) days of receipt of the invoice from Licensor.



Timeframes:

- (a) Licensor will approve, approve with conditions (e.g., if Make Ready is required), or deny Licensee's Application within sixty (60) days after the receipt of a completed Application, provided that, all attachments at all locations of the Application are substantially similar.

If Licensee's Application is approved or if Licensee's Application is not rejected within the applicable period specified above, the Application will be considered approved and the Licensee will have the right to place Attachments on such Pole(s) as provided in this Agreement. If Licensee's Application is conditionally approved, Licensor will include a Make Ready Estimate with its response. If the Licensor rejects the Application in whole or in part, the Licensor will specify the reason(s). The Application will be rejected only for good cause, as provided for in Article 1.

4. The Make Ready Estimate will offer sufficient detail so that Licensee can readily identify the components of the proposed Make Ready Work and will reflect costs that are verifiably comparable with Licensor Actual Costs. If necessary, the Licensee will request clarification on the Make Ready Cost before requesting the Licensor to commence Make Ready Work. The Licensor's total charges will be consistent with Article 8 herein (will not exceed 120% of the estimate), unless such additional costs are caused by changes in Licensee's plans from the original permit. Licensee will provide written acceptance of the Make Ready Estimate within fourteen (14 days) of receipt. If written response, is not provided within fourteen (14) days, the Application will be considered denied.

5. Licensor will complete Make Ready Work on Applications within sixty (60) calendar days of receipt of Licensee's written acceptance of the Make Ready Estimate for such Make Ready Work. Licensee may request expedited handling of Licensor's work, and Licensee will be responsible for the additional Actual Costs incurred by Licensor for such expedited processing. Licensee is responsible for coordination of all other Licensees or Joint Users to similarly expedite the completion of all Make Ready Work. Licensee will make payment for Licensor's Make Ready Work within sixty (60) days of the written acceptance.

6. Any work undertaken on or in furtherance of Licensee's use of the equipment Above the Communications Space of any pole, will be performed by Licensor's employees, Licensor's contractors, or approved contractors (Exhibit 5). Unless otherwise specifically approved in advance by Licensor, neither the Licensee, nor its contractors will be allowed to perform the Make-Ready Work related to Licensee's equipment Above the Communications Space.

7. Licensor will provide written notice to Licensee no later than seven (7) business days following the completion of Make Ready Work. Upon receipt of notice by Licensee from Licensor that the Make Ready work has been completed, the Licensee will have the right hereunder to place its Attachments in accordance with the terms of the Application and this Agreement (including Article 3 herein). If the Licensee fails to initiate construction within one hundred eighty (180) days from the Licensor's notice of completion of Make Ready Work, the Licensor may, in its sole discretion, deem the Application approval terms and conditions outlined in the Appendix A null and void,

and require the submission of another Application, along with engineering fees necessary to reimburse the Licensor for revised engineering and cost estimates, in the event Licensee still desires to attach to the Poles originally approved for attachment. Where field conditions preclude such compliance (e.g., when the Licensee's construction is delayed), Licensee will notify the Licensor prior to the one hundred eightieth (180<sup>th</sup>) day. Licensee will provide written notice to Licensor no later than twenty (20) business days following the completion of Licensee's work so that Licensor may perform its inspection of Licensee's new or modified Attachments to Licensor's Pole.

(a) Licensee and Licensor will each place, Transfer and rearrange its own Attachments and will place guys and anchors to sustain any unbalanced loads caused by its Attachments. Anchors and guys will be in place and in effect prior to the installation of Attachments and cables. Each Party will, with due diligence, attempt at all times to execute such work promptly and in such manner as not to interfere with the service of the other Party.

(b) The cost of making Attachments on existing Poles as provided herein, including the making of any necessary Pole replacements, will be borne by the Parties hereto in the manner provided in Article 8.

8. Any work undertaken on or in furtherance of Licensee's use of the equipment Above the Communications Space of any pole, will be performed by Licensor's employees, Licensor's contractors, or approved contractors (Exhibit D). Unless otherwise specifically approved in advance by Licensor, neither the Licensee, nor its contractors will be allowed to perform the Make-Ready Work related to Licensee's equipment Above the Communications Space. For Licensor's failure to meet the required timelines for Make-Ready Work Above the Communications Space, as set forth in this section, as applicable, Licensee, after attempting to resolve the dispute, may file a complaint for unreasonable delay on the part of Licensor with the FCC or with the state public utilities commission exercising jurisdiction or other authority; and further, a rebuttable presumption applies in such proceedings that access to Licensor's poles or facilities has not been provided on just and reasonable terms and conditions.

9. Post Inspection. Licensor may perform a post-construction inspection to measure and/or to visually observe Licensee's facilities, within thirty (30) days of completion of construction to ensure the attachment and installation of the Licensee's facilities conform to the requirements of this Agreement. Licensee will bear the reasonable and actual costs of such inspection provided the inspection is completed within thirty (30) days after written notification by Licensee of non-compliance. If the Licensee's facilities are not in compliance, the Licensee will bring its facilities into compliance within thirty (30) days after notification of non-compliance and notify Licensor in writing upon completion. Licensee will bear the reasonable and actual costs of all subsequent inspections necessary to verify the facilities have been brought into compliance. If not brought into compliance within ninety (90) days from initial notification from Licensor, Licensor may have an approved contractor perform the work and Licensee will be responsible for cost.

## ARTICLE 5 – RADIO FREQUENCY

A. Radio Frequency Emissions. Licensee is solely responsible for the radio frequency (“RF”) emissions emitted by its equipment. Licensee is jointly responsible for ensuring RF exposure from its emissions, in combination with the emissions of all other contributing sources of RF emissions, is within the limits permitted under all applicable rules of the Federal Communications Commission (“FCC”). To the extent required by FCC rules, Licensee will install appropriate signage to notify workers and third parties of the potential for exposure to RF emissions. Licensee will communicate and cooperate with other pole attachers which emit RF to minimize the number of signs.

B. Each Party and Other’s Responsible for Own Equipment. The Licensor, Licensee and other attachers which emit RF on Licensor’s poles are under a duty and obligation in connection with the operation of its own, facilities, now existing or in the future, to protect against RF interference to the RF signals of Licensor, Licensee, and such other attachers, as applicable, as may emanate or arise. Each party to this Agreement and all others on poles or facilities will endeavor to correct any interference to other networks created by its RF emissions promptly and will coordinate and cooperate with each other relating to the same.

C. RF Power Cut-off Switch. Licensee will install a power cut-off switch on every Licensor pole or facilities to which it has attached facilities that can emit RF energy. In ordinary circumstances, Licensor’s authorized field personnel will contact the Licensee’s designated point of contact provided pursuant to Section 22 to inform the Licensee of the need for a temporary power shut-down. Upon receipt of the call, Licensee will power down its antenna remotely, which power-down will occur during normal business hours and with 24 hours advance notice. In the event of an unplanned power outage or other unplanned cut-off of power, or an emergency, the power-down will be with such advance notice as may be practicable and, if circumstances warrant, employees and contractors of Licensor may accomplish the power-down by operation of the power disconnect switch without advance notice to Licensee and will notify the Licensee as soon as possible. In all such instances, once the work has been completed and the worker(s) have departed the exposure area, the party who accomplished the power-down will restore power and inform Licensee as soon as possible that power has been restored.

D. Emergency After Hours Contact Information. Licensee will provide emergency after hours contact information to Licensor including 24/7 telephone and/or pager information, a list of duty managers by district and escalation procedures. Licensee will be required to include signage which indicates Licensor emergency contact information, Licensee’s emergency contact information, and National Electrical Safety Code (“NESC”) required information.

E. Installation and Upkeep of Sign(s). Licensee is responsible for the installation and upkeep of its sign or signs on each pole. The signage will be placed so that it is clearly visible to workers who climb the pole or ascend by mechanical means. The signs will contain the information approved for such signs by the FCC, or in the absence of FCC approval, the information commonly used in the industry for such signs.

## **ARTICLE 6 – RIGHT OF WAY FOR LICENSEE'S ATTACHMENTS**

While the Licensor and Licensee will cooperate as far as may be practicable in obtaining right-of-way for both parties on Licensed Poles, the Licensor does not warrant or assure to the Licensee any right-of-way privileges or easements on, over or across streets, alleys and public thoroughfares, and private or publicly owned property, and if the Licensee will at any time be prevented from placing or maintaining its Attachments on the Licensor's Poles, no liability on account thereof will attach to the owner of the Poles.

Licensor will maintain pole line right-of-way clearances according to Licensor's standard procedures, except with respect to Make Ready. Licensee is responsible for providing right-of-way clearances outside of Licensor's standard clearance practices at its own expense.

## **ARTICLE 7 – MAINTENANCE OF POLES AND ATTACHMENTS**

A. The Licensor will maintain all Poles in a safe and serviceable condition and in accordance with the Specifications, and will replace, reinforce or repair Poles as they become defective. Licensee acknowledges that Poles and related items carry hazardous voltages, deteriorate over time and may contain various hazardous chemicals or properties. Licensee will instruct and equip its personnel, including its employees, contractors and other agents, of the hazards associated with working on Licensor's Poles, and Licensee will provide necessary training and equipment for its representatives to safely execute their work on Licensor's Poles. Prior to working on a Pole, Licensee will, through visual inspection and reasonable effort, make an assessment that the pole is in safe working condition. If Licensee believes that a pole contains non-compliant or unsafe conditions, Licensee will promptly notify Licensor of any existing substandard condition (i.e., physical, mechanical or electrical, etc.), that jeopardizes either the general public or workman safety, and Licensor will cause the existing condition to be promptly corrected. Licensee will insure that contractors will comply with provisions of this Agreement. Licensor does not warrant, guarantee, or imply that any Pole abandoned by Licensor possesses sufficient mechanical strength as required by or for any use of Licensee.

B. When replacing a Pole carrying terminals of aerial cable, underground connection, or transformer equipment, the new Pole will be set in the same hole which the replaced Pole occupied, or immediately adjacent, and in a manner to facilitate Transfer of Attachments, unless special conditions make it desirable to set it in a different location. Replacement Poles where risers (dips) are installed should be set as close as possible to the existing Pole. The Licensor will make reasonable effort to conduct a joint field review or otherwise coordinate with Licensee to determine the location of the proposed Pole. Reasonable effort will be made to coordinate locations of risers and Service Drops with the locations of the power facilities serving the customer.

C. Except during restoration efforts after natural disasters, such as a Force Majeure events, whenever it is necessary to replace or relocate a Licensed Pole, the Licensor will, before making such replacement or relocation, give notice via the electronic notification system of pole transfer request provided by the National Joint Utilities Notification System ("NJUNS") of not less than sixty (60) days for five (5) poles or less and ninety (90) days for six (6) poles or more (except in case of emergency, when verbal notice will be given and subsequently confirmed in writing) to the Licensee, specifying in such notice the time of such proposed replacement or relocation, and the Licensee will at the time so specified Transfer its Attachments to the new or relocated Pole. On highway relocation projects, the schedule for

Transfers will be consistent with the “utility adjustment schedule” and any subsequent revisions or with any other schedule issued by the appropriate authority governing a highway relocation project.

NJUNS code Licensor CTYOXF

NJUNS code Licensee ATMDEK

D. Should the Licensee fail to Transfer its Attachments to the newly Licensed Pole after the date specified for such Transfer of Attachments and after all third party and Licensor responsible Transfers have been accomplished to the extent necessary for Licensee to affect its facilities Transfer, whichever is later (“Licensee Transfer Date”), the parties will have the following rights, in addition to any other rights and remedies available under this Agreement: The Licensor may hire a contractor approved by Licensee to transfer the facilities at Licensee’s cost. Licensee will furnish a list of contractors authorized to perform such transfers. Alternatively, Licensor may sell such Pole to Licensee “as is” and the Licensee will indemnify, defend and save harmless the Licensor from all obligation, liability, damages, cost, expenses or charges incurred thereafter, and not arising out of anything occurring prior to the transfer of ownership. Licensor will further evidence transfer of title to the Pole by appropriate means.

E. Licensee will have twenty-four hour (24/7) access to its equipment in Communications Space for maintenance and repair.

F. Each party will at all times maintain all of its Attachments in accordance with the Specifications in Article 3.

#### **ARTICLE 8 – DIVISION OF COSTS**

A. **NEW POLES INSTALLED WHERE NONE CURRENTLY EXIST.** Whenever Licensor requires new Pole facilities within the Licensee’s service territory for any reason, including an additional Pole line, an extension of an existing Pole line, or in connection with the reconstruction of an existing Pole line, it will make a best effort to notify Licensee to that effect in writing (verbal notice subsequently confirmed in writing may be given in cases of emergency) stating the proposed location of the new Pole. In the case of emergency, the Licensee will preliminarily respond verbally on an expedited basis that it does or does not want to attach its Attachments and will generally describe its planned Attachments. Within a reasonable period (not to exceed fifteen (15) business days) after the receipt of such written notice, the Licensee will submit an Application. To the extent that Licensee’s planned Attachments require a pole taller or stronger than what Licensor would have installed absent Licensee’s planned Attachments, the difference between the Cost in Place of such Pole and the Cost in Place of the existing Pole will be paid by the Licensee, the rest of the cost of erecting such Pole to be borne by the Licensor. If in connection with the construction of a Pole(s) the Licensee makes the payment required by this paragraph, then the Licensee will in the future be entitled to attach on such Licensor’s Pole(s) even if the Pole(s) does not at that time become a Licensed Pole.

B. **ADDITIONAL MID-SPAN POLE.** A Pole, including all appurtenances or fixtures, erected between Poles to provide sufficient clearance and furnish adequate strength to support the circuits of both the Licensor and the Licensee, which would have been unnecessary except solely due to Licensee’s use, will be erected at the sole expense of the Licensee, or in the case

of multiple Licensees on the Licensed Pole, the cost will be equally divided among all Licensees or Joint Users requiring the mid-span Pole.

C. **PAYMENTS DO NOT AFFECT OWNERSHIP.** Any payments for Poles made by the Licensee under any provisions of this Article will not entitle the Licensee to the ownership of any part of said Poles for which it has contributed in whole or in part.

D. **REPLACEMENT OF EXISTING POLES.** Where an existing Pole is replaced for maintenance purposes, Licensor will erect a Pole adequate for the existing Attachments and Attachments for which Applications have been delivered, unless such Application is denied in accordance herewith, and the Licensor will pay all the costs of installing the replacement Pole. Licensee will pay to replace its existing Attachments. The replaced Pole will be removed and retained by Licensor.

1. A Pole larger than the existing Pole, which is installed to replace an existing Pole, the extra height or strength of which is due wholly to the Licensor's requirements, such as providing service, normal maintenance, or keeping the Licensor's wires clear of trees, will be erected at the sole expense of the Licensor. The Licensor will bear the full expense of replacing or Transferring all the Licensor's Attachments, and the Licensee will bear the full expense of replacing or Transferring all the Licensee's Attachments.

2. For a Pole larger than the existing Pole, which is installed to replace an existing Pole, the extra height or strength of which is due wholly to the Licensee's requirements, including Licensee's requirements as to keeping the Licensee's wires clear of trees, the Licensee will pay to the Licensor the Make Ready Cost of the new Pole.

3. For a Pole larger than the existing Pole, which is installed to replace an existing Pole, the extra height or strength of which is due wholly to a Joint User's requirements such as providing service, correcting a safety violation or keeping the Joint User's wires clear of trees, the Joint User will pay all of the Make Ready Cost of the new Pole, including any costs associated with replacing or Transferring Licensee's Attachments.

4. Except as to existing contracts with Joint User, in the case of a Pole larger than the existing Pole, which is installed to replace an existing Pole, the extra height or strength which is due to the requirements of all parties on the pole, such as when the parties share responsibility for correcting a safety violation, the difference between the Cost in Place of such Pole and the Cost in Place of the existing Pole will be shared equally by the Licensee and the Licensor, and other third parties, if applicable, the rest of the cost of erecting such Pole to be borne by the Licensor. The Licensor and Licensee will replace or Transfer all Attachments at their own expense.

E. **RESPONSIBILITY FOR OWN ATTACHMENTS.** Each party will place, maintain, rearrange, Transfer and remove its own Attachments at its own expense except as otherwise expressly provided herein.

F. **PAYMENT BASIS.** Payments made under the provisions of this Article may be based on the estimated or Actual Cost as mutually agreed upon (including overhead) of making such changes but in no event, however, will either Party be required to pay for such changes more than 120% of the Estimated Cost supplied by the other if such cost estimate will have been requested and furnished before the changes were made.

G. UTILITIES INSTALLING LARGER POLES FOR UTILITY'S FUTURE USE. In the event the Licensor installs a Pole larger than is initially required for Licensor's and Licensee's use in anticipation of Licensor's future requirements or additions, the additional space provided by Licensor will be reserved for Licensor's sole use. Licensee may request documentation to validate the need for future space.

## **ARTICLE 9 – INSPECTIONS**

A. INSPECTION PERFORMANCE. Within a reasonable time, not to exceed two (2) years after the Effective Date of this Agreement, the Parties will jointly perform a safety inspection to identify any safety violations of all parties on the Poles ("Initial Safety Inspection"), including Licensor and Joint Users, except that no such Initial Safety Inspection will occur if Licensee does not have any existing Attachments, which the parties agree is the case here. Following the Initial Safety Inspection, and not more than once every five (5) years thereafter (or five (5) years after execution of this Agreement if an Initial Safety Inspection is not conducted), Licensor may perform periodic system-wide safety inspections of Licensor Poles, including Licensee Attachments, upon six (6) months' advance written notice to Licensee. Such notice will describe the scope of the inspection and provide Licensee with an opportunity to participate. Licensee and Licensor, and other attachers to Licensed Poles, will share equally in the Initial Safety Inspection cost whether the Initial Inspection is performed by the Licensor or a third party contractor. In the event the Initial Safety Inspection or any subsequent safety inspection is performed by a third party contractor, the Licensee will have the right to seek bids from third party contractors prior to the inspection and propose such bids to Licensor. Licensor will not be required to use any third party contractor proposed by the Licensee, provided that any third party contractor used by the Licensor to perform any inspection will charge no more than the lowest qualified bid proposal (in Licensor's reasonable discretion) provided by the Licensee. For inspections performed after the Initial Inspection, Licensee will pay a pro-rata share of the Licensor's inspection costs and will incur its own costs to participate in such periodic safety inspections. The Licensee's pro-rata share of Licensor's cost will be equal to the percentage of the total violations caused by Licensee's Attachments as identified during the inspection.

B. CORRECTIONS. In the event any Licensee facilities are in violation of the Specifications and such violation poses an imminent danger to persons or property and is discovered ("Imminent Danger Violation"), Licensee will correct such violation immediately. Should Licensee fail to correct such Imminent Danger Violation after notice, the Licensor may correct the Imminent Danger Violation and bill Licensee for the Actual Costs incurred. Licensee will not be subject to any safety violation penalties pursuant to the Initial Safety Inspection provided that Licensee corrects any safety violation that is not an Imminent Danger Violation (a "Non-Imminent Danger Violation") discovered during the Initial Safety Inspection within eighteen (18) months of the documentation and reporting of the unsafe conditions. Following the Initial Safety Inspection, if any Attachment of the Licensee is found to be a Non-Imminent Danger Violation of Article 3 herein, and Licensee has caused the violation, Licensee will have sixty (60) days to correct any such violation upon written notice from Licensor, or within a longer, mutually agreed-to time frame if correction of the violation is not possible within sixty (60) days, such extended time to be not more than an additional sixty (60) days. Notwithstanding the foregoing grace periods, in the event Licensor or an Outside Party prevents Licensee from correcting a Non-Imminent Danger Violation, the timeframe for correcting such violation will be extended to account for the time during which Licensee was

unable to correct the violation due to such Licensor or Outside Party's action. Licensee will not be responsible for the costs associated with violations caused by others. In all circumstances, all of the Parties on the Pole will work together to maximize safety while minimizing the cost of correcting any such deficiencies, but the Licensee will be responsible for the full cost of any necessary or appropriate corrective measures associated with violations caused by Licensee, including removal and replacement of the Pole and all Transfers or other work incident thereto. Licensee will insure that its employees, agents, contractors or other Outside Parties, which Licensee causes to work on Licensor Poles, will be notified of pending, unresolved Poles requiring corrective actions prior to activities on such Poles, and Licensee will not allow unqualified or improperly equipped personnel to work on such Poles.

1. If any Attachment of the Licensor is found to be in violation of Specifications and Licensor has caused the violation, then the parties will work together to minimize the cost of correcting any such deficiencies, but the Licensor will be responsible for the full cost of any necessary or appropriate corrective measures, including removal and replacement of the Pole and all Transfers or other work incident thereto.

2. If one or more Outside Party's Attachment caused the violation, then such Outside Party will pay the corrective costs incurred by all who have Attachments on the Pole, including for the Licensee, Licensor and any other attachers; and the Licensor will make reasonable effort to cause the Outside Party to make such payment.

3. If there exists a violation of Specifications and it cannot be determined which party on the Pole, including Joint User, caused such violation or there is a mixture of the parties causing the violation, then the parties will work together to minimize the cost of correcting any such deficiencies, and all parties and Outside Parties who may have caused such violation will share equally in such costs; provided, however, that if a Party can modify its Attachments so that they no longer may be a cause of the violation or deficiency, then such Party may elect to make such modification instead of otherwise sharing in such costs. Such a modification will not relieve a Party from sharing in such costs if the Party making the modification could have been a cause of any deficiency that remains.

C. In the event an Imminent Danger Violation is discovered, Licensee will correct such violation immediately, and, in any case, in no more than twenty-four (24) hours, except as otherwise agreed to by the Parties. Should Licensee fail to correct such Imminent Danger Violation within twenty-four (24) hours after notice or such alternative time period, the Licensor may correct the violation and bill Licensee for the Actual Costs incurred.

## **ARTICLE 10 – UNAUTHORIZED ATTACHMENTS**

If any Attachment is identified for which the Application requirements (as set forth herein), or notification requirements as provided for in Article 4, have not been satisfied ("Unauthorized Attachment"), Licensor will notify Licensee in writing. The Licensee will pay to the Licensor a one-time fee of one hundred fifty dollars (\$150.00) per Unauthorized Attachment. Licensee will also submit a completed application to Licensor within five (5) business days and be subject to the provisions in Article 4.



## **ARTICLE 11 – ATTACHMENT COUNTS**

A. Not more often than once every five (5) years and in conjunction with the established cyclical attachment count, unless otherwise mutually agreed by the parties, inventories of Attachments will be made by representatives of the parties to determine the number of Licensee's Attachments to Licensor Poles ("Actual Inventory"). Licensor will provide three (3) months' advance written notice prior to the Initial Inventory and any subsequent Actual Inventory describing the scope of the Inventories so that Licensee may plan and fully participate in and budget for such Inventories.

B. Unless prevented by the provisions of a third party agreement, Actual Inventories and Initial Inventories will include all Outside Parties attached to Licensor's Poles. Where multiple Outside Parties are included in the inventory, all participating Outside Parties will incur a prorated share of the cost of performing the Actual Inventory, based on the number of Attachments each attacher has on Licensor's Poles. For a year for which there is an Actual Inventory, the Rental Fees provided for herein will be based on the Actual Inventory and the following adjustments will be made:

1. The difference between the number of Licensee Attachments found by the Actual Inventory for the year in question and the number of Attachments for which Licensee was most recently invoiced for Pole Attachment Rental Fees will be prorated evenly based on the assumption that such Licensee Attachments were added evenly over the period since the last Actual Inventory, or five years, whichever period is shorter. In addition, the Unauthorized Attachment fee will apply if applicable.

2. If the number of Licensed Attachments in the previous annual rental invoice is less than the number of Licensed Attachments found by the Actual Inventory, then Licensee will be entitled to a pro-rata refund from the Licensor or a credit to the Licensee based on the assumption that such Licensee Attachments were removed evenly over the period since the last Actual Inventory, or five years, whichever period is shorter..

## **ARTICLE 12 – ABANDONMENT OF LICENSED POLES**

A. To the extent permitted by law, if the Licensor desires at any time to abandon any Licensed Pole, it will, except in the event of required Transfers as provided in Article 7, give the Licensee notice in writing to that effect at least sixty (60) days prior to the date on which it intends to abandon such Pole. If, at the expiration of sixty (60) days, the Licensor and all other third party and Joint Users have no Attachments on pole but Licensee has not removed its Attachments, Licensor may sell such Pole to Licensee "as is" and the Licensee will save harmless the Licensor from all obligation, liability, damages, cost, expenses or charges incurred thereafter, and not arising out of anything occurring prior to the transfer of ownership. Licensor will further evidence transfer of title to the Pole by appropriate means.

B. The Licensee may at any time abandon a Licensed Pole by removing any and all Attachments it may have thereon and by giving written notice thereof.

## ARTICLE 13 – POLE ATTACHMENT RENTAL FEES

- A. For a year in which there is no Inventory, the number of Licensee's Attachments used in calculating the Rental Fees will be based on the number of Licensee Attachments for which Licensee was charged in the previous year plus the number of Licensee Attachments approved through the Application process since the last billing minus the number of Licensee Attachments for which notice of removal was provided.
- B. The applicable computation of payments and calculations as above provided will be made on or about December 15th of each year for the next year's Rental Fees, each Party acting in cooperation with the other.
- C. Pole Attachment Rental Fees due from Licensee to Licensor will be as indicated in Exhibit 2. The undisputed Pole Attachment Rental Fee herein provided will be paid by Licensee within sixty (60) days after Licensee's receipt of the invoice.
- D. SPECIFIC RENTAL RATES. See Schedule 2.
- E. Licensor hereby represents and warrants as of the date hereof and covenants and agrees from and after the date hereof that none of the rates or fees offered to any other entity with respect to wireless installations is or will be more favorable to such entity than those imposed on Licensee under this Agreement. If Licensor agrees to a rate or fee that is more favorable than those imposed on Licensee under this Agreement, then Licensee will be entitled under this Agreement to such rate or fee on and after such rate or fee becomes effective.

## ARTICLE 14 – DEFAULTS

- A. In the event either Party deems an event of default has taken place and prior to engaging in the formal default provisions in this Agreement, the appropriate representatives of the Licensee and Licensor, as identified in Article 20, will meet in person or on the telephone to attempt to resolve the matter in good faith within ten (10) business days of the initial request of either Party to meet.
- B. In the absence of resolution of the matter in accordance with Article 14.A., the aggrieved Party may provide a notice of default to the other Party in writing. Upon receipt of such notice of default, the defaulting Party will either work diligently and cooperatively with the non-defaulting Party to correct such default or present sufficient evidence that a default does not exist or is not the fault of the defaulting Party. If such default will continue for a period of sixty (60) days after such notices, either Party may, at its sole discretion and option, terminate this Agreement in full if the default pertains to all poles, or, if Licensee is the defaulting Party, Licensor may deny future Attachments and/or remove the Attachments of Licensee to which the default pertains at Licensee's expense. Notwithstanding the foregoing, the cure periods may be extended upon mutual agreement of the Parties if a cure is not reasonably possible within the time frames specified above.
- C. Without limiting the effect of the immediately preceding paragraph, if after reasonable notice, Licensee will default in the performance of any work it is obligated to do under this Agreement, the Licensor may elect to do such work, and the Licensee will reimburse the Licensor for the cost thereof. Licensor will notify the Licensee in advance of its intent to do the work and the approximate cost of doing such work. Failure on the part of the Licensee to make

such a payment, as set forth in Article 19 herein, will, at the election of the Licensor, constitute a default under Section B of this Article 14.

#### **ARTICLE 15 – RIGHTS OF OTHER PARTIES**

A. If Licensor, prior to the execution of this Agreement, received or conferred upon others, not parties of this Agreement (“Outside Parties”), by contract or otherwise, rights or privileges to attach to, and/or reserve space on any of its Poles covered by this Agreement, nothing herein contained will be construed as affecting said rights or privileges with respect to existing Attachments of such Outside Parties, which Attachments will continue in accordance with the present practice. All future Attachments of such Outside Parties will be in accordance with the requirements of the following paragraph, except where such Outside Parties have, by agreements entered into prior to the execution of this Agreement, acquired enforceable rights or privileges to make Attachments which do not meet such space allocations. Licensor will derive all of the revenue accruing from such Outside Parties. Any contractual rights or privileges of Outside Parties recognized in this paragraph will include renewals of or extensions of the term (period) of such contracts.

B. In the event any Pole or Poles of Licensor to which Licensee has made its Attachments would, but for the Attachments of Licensee, be adequate to support additional facilities desired by Licensor, Licensor’s subsidiary or affiliate, or by a Joint User with whom Licensor has a prior agreement and which Joint User is either occupying space or has requested to attach or reserve space on such Pole(s) prior to the placement of Licensee’s Attachment on such Pole(s), then Licensor will notify Licensee of any changes necessary to provide an adequate Pole or Poles and Licensor or Joint User will reimburse Licensee for the incremental costs thereof. Should Licensee submit a request to make a new Attachment on a Pole that a Joint User is not already attached to but on which the Joint User has reserved space, Licensor will provide notice of such space reservation to Licensee, provided that Licensor has such knowledge on or prior to the date of Licensee’s Attachment request.

C. If Licensor desires to confer upon Outside Parties, by contract or otherwise, rights or privileges to attach to any of its Poles covered by this Agreement, it will have the right to do so, provided all attachments of such Outside Parties are made in accordance with the following: (1) such attachments will be maintained in conformity with the requirements of Specifications, (2) such attachments will not be located within the space allocation of Licensee and (3) such Attachments will not interfere with Licensee’s Attachments. Licensor will derive all of the revenue accruing from such Outside Parties.

#### **ARTICLE 16 – ASSIGNMENT OF RIGHTS**

The rights conferred by this Agreement may be transferred by the Licensee to any successor in interest that has or is contemporaneously granted a franchise by the applicable franchise authority upon thirty (30) days written notice to the Licensor. Except as otherwise provided in this Agreement, including the immediately prior sentence, Licensee will not assign or otherwise dispose of this Agreement or any of its rights or interests hereunder, or in any of the Licensed Poles, or the Attachments or rights-of-way covered by this Agreement, to any firm, corporation or individual, without the written consent of the Licensor, which consent will not be unreasonably withheld or delayed, except to the United States of America or any agency thereof; provided, however, that nothing herein contained will prevent or limit the Licensee’s right to mortgage any or all of its property, rights, privileges, and franchises, or lease or

transfer any of them to another corporation organized for the purpose of conducting a business of the same general character, or to enter into any merger or consolidation; and, in case of the foreclosure of such mortgage or in case of lease, transfer, merger, or consolidation, its rights and obligations hereunder will pass to, and be acquired and assumed by, the purchaser at foreclosure, the transferee, lessee, assignee, merging or consolidating company, as the case may be; and provided further that, subject to all of the terms and conditions of this Agreement.

#### **ARTICLE 17 – WAIVER OF TERMS OR CONDITIONS**

The failure of either Party to enforce or insist upon compliance with any of the terms or conditions of this Agreement will not constitute a general waiver or relinquishment of any such terms or conditions, but the same will be and remain at all times in full force and effect.

#### **ARTICLE 18 – PAYMENT OF TAXES**

Each Party will pay all taxes and assessments lawfully levied on its own property upon said Licensed Poles, and the taxes and the assessments which are levied on said Licensed Poles will be paid by the owner thereof, but any tax, fee, or charge levied on Licensor's Poles solely because of their use by the Licensee will be paid by the Licensee, except for any such tax, fee, or charge levied by Licensor, excluding any tax, fee, or charge hereunder or any business use tax related to franchise or franchise agreement.

#### **ARTICLE 19 – BILLS AND PAYMENT FOR WORK**

A. Upon the completion of work performed hereunder by either Party, the expense of which is to be borne wholly or in part by the other Party, the Party performing the work will present to the other Party within ninety (90) days after the completion of such work an itemized statement of the costs, and such other Party will, within sixty (60) days after such statement is presented, pay to the Party doing the work such other Party's proportion of the cost of said work.

B. All amounts to be paid by either Party under this Agreement will be due and payable within sixty (60) days after receipt of an itemized invoice. Except as provided in Article 19.C below, any payment not made within sixty (60) days from the due date will bear interest at the rate of 1.5% per month until paid, or if 1.5% exceeds the maximum rate allowed by law, then at the maximum rate allowed by law. If a Party bills the interest provided for in this paragraph but then receives a payment showing that the payment was timely made, the billing Party will write off and cancel the interest.

C. A Party receiving a bill may, in good faith and for good cause, dispute the amount or adequacy of substantiation for the bill. In the event that a Party so disputes only a portion of a bill, then such Party will promptly pay the undisputed amount. In the event of such dispute, the Parties will meet, by telephone or in person, within ten (10) business days of a dispute being raised to discuss the disputed item and establish a procedure for addressing the disputed amount in accordance with this Agreement. Upon resolution of the dispute, if the amount and substantiation were correct and sufficient, interest will be paid on the unpaid balance from the date of the initial bill at the rate of 1.5% per month until paid, or if 1.5% exceeds the maximum rate allowed by law, then at the maximum rate allowed by law; but, if the amount was not correct or substantiation was not sufficient, no interest will be payable unless the amount determined to be correct is not paid within sixty (60) days of receipt of substantiation and

determination of the correct amount, in which case interest will be payable for the period beginning after the end of such sixty (60) day period.

D. Except as to the rental fees, the fees specified in this Agreement will be subject to an annual adjustment equal to the change in the most recent twelve month's Handy-Whitman Index for the South Atlantic Region, Account 364, Poles, Towers and Fixtures.

## ARTICLE 20 – NOTICES

A. Except as otherwise provided in this Agreement, all notices and writings will be made to the people ("Contact Person(s)") identified below, who from time to time may be changed by written notice.

B. By written notice pursuant hereto, a Party may from time to time specify a person in lieu of the person designated in Section A above to receive notices or writings with respect to specified matter(s) and/or geographic area(s), in which case such notices or writings will be sent to that person as to such matter(s) and area(s).

C. Response to any notice or Application will be made to the sender rather than to the person designated in Section A or B above.

D. Unless otherwise provided in this Agreement, any notice will be in writing, which may, when mutually agreeable, include preservable and traceable electronic means, such as email or facsimile.

E. A second copy of any notice given under Article 14 or Article 22 of Agreement will be given to the following persons, who may from time to time be changed by written notice:

If to Licensor:  
City of Oxford  
Attn: City Manager  
110 West Clark Street  
Oxford, GA 30054  
770-786-7004

With a copy to:  
Electric Cities of Georgia  
Christine Carling  
1470 Riveredge Parkway NW  
Atlanta, GA 30328  
770-919-6308  
ccarling@ecoga.org

If to Licensee:

New Cingular Wireless PCS, LLC  
Attn: Tower Asset Group- Lease Administration  
Re: Cell Site #: \_\_\_\_\_; Cell Site Name: \_\_\_\_\_  
Fixed Asset #: \_\_\_\_\_; State Where Site Located: GA  
575 Morosgo Drive NE  
Atlanta, GA 30324

With a copy to:  
New Cingular Wireless PCS, LLC  
Re: Cell Site #: \_\_\_\_\_; Cell Site Name: \_\_\_\_\_  
Fixed Asset #: \_\_\_\_\_; State Where Site Located: GA  
AT&T Legal Department – Network  
208 S. Akard Street,  
Dallas, TX 75202-4206

F. In the event of the need for a temporary power shut-down, Licensor's authorized field personnel will contact Licensee at 1-800-638-2822 or other telephone number provided by Licensee and follow the instructions prior to working within one (1) foot of Licensee's equipment which emits RF.

G. The Parties will develop and maintain a joint form designating the people to whom notices will be given pursuant to the foregoing.

Except as otherwise noted, all notices, requests, demands and other communications hereunder will be in writing and will be delivered personally with a receipt evidencing delivery, sent by nationally recognized overnight courier, in each case addressed to the appropriate Party at the address for such Party shown above or at such other address as such Party will have previously designated by written notice delivered to the Party giving such notice. Except as otherwise permitted, any notice given in accordance herewith will be deemed to have been given and received when delivered to the addressee, which delivery may be evidenced by signed receipt of the addressee given to the courier or postal service

## **ARTICLE 21 – RESOLUTION OF CERTAIN DISPUTES**

A. In the event of a dispute regarding any compliance or non-compliance with the provisions of Article 3 of this Agreement, including which Party, if any, is responsible for any non-compliance and what corrective action, if any, is necessary or appropriate to remedy any such non-compliance, then the Parties will each arrange for a representative to make a joint field visit to the Pole location to investigate whether a violation exists and if so, any corrective action needed and the Party or Parties responsible. The Parties will make a diligent and good faith effort to resolve such disputes at the local level by the Parties' respective local engineers and local managers.

B. If the Parties are unable to resolve any such dispute at the local level, then either Party may submit the matter for resolution to a "Referee," as defined below, for binding resolution. A matter will be submitted to the Referee by sending a letter (by mail or hand-delivery) to the Referee, with a copy provided to the other Party's representative who was involved in the attempt to resolve the dispute and the other Party's representative designated pursuant to

Article 21.A or Article 21.B before or concurrently with the transmission of the letter to the Referee. The letter will include a summary of the dispute and will designate the Party's Contact Person for the dispute. The other Party will promptly respond with a letter similarly sent and copied that provides such Party's summary of the dispute and designates such Party's Contact Person for the dispute.

C. If the Parties mutually agree to do so, instead of proceeding under Section B above, the Parties may submit any dispute to the Referee by jointly sending the Referee a letter that includes a summary of the dispute and designates each Party's Contact Person for the dispute.

D. The Referee will make such investigation as deemed appropriate in his or her discretion, which will include hearing from each Party's Contact Person. The Referee may, but is not required to, engage in such other procedures or hearing as the Referee deems appropriate. The Parties will cooperate with the Referee.

E. The Referee will promptly issue a binding decision (to the extent permitted by law) in writing to the Parties, from which there will be no appeal. The Party whose position is not upheld by the Referee (which determination may be made by the Referee if requested to do so) will be required to pay for the Referee's fees and expenses. If both Parties' positions are upheld in part, they will share the Referee's fees and expenses equally. The Parties agree to be bound to pay the Referee's fees and expenses as provided herein.

F. The Referee will be appointed as follows:

1. Each Party will appoint an outside engineer or other qualified person and these two (2) appointees will appoint a third outside engineer or other qualified person (the "Referee") to serve as the Referee.

2. In the event that the two (2) appointees are unable within fourteen (14) days to agree upon a third outside engineer or other qualified person who is willing and able to serve as the Referee, then the Referee will be appointed as follows: Three (3) names will be blindly drawn from the list of persons then comprising the NESC committee whose work is most closely related to the dispute (e.g., Clearances Committee or Strength and Loading Committee), or such other group as may be mutually agreed upon. Each Party will strike one such name and the remaining person will serve as the Referee. If the Parties strike the same name, then the Referee will be selected from the remaining two (2) names by coin toss. If the NESC committee member so selected is unwilling or unable to serve as Referee, then this procedure will be repeated (starting with the blind drawing of three different names as provided above) as necessary until a Referee is selected who is willing and able to serve as Referee. If all committee member names of the NESC committee first selected are exhausted without a Referee being appointed who is willing and able to serve as Referee, then the Parties will repeat the above-described procedure with the next NESC committee whose work is most closely related to the dispute, and so on until a Referee is selected who is willing and able to serve as Referee.

G. Nothing herein will preclude the Parties from entering into any other mutually agreeable dispute resolution procedure or from changing by mutual written agreement any aspect of the foregoing procedures. Without limiting the generality of the foregoing, the Parties may by mutual written agreement remove, replace or appoint a Referee at any time.

H. The Parties agree, that if any dispute arising under this Agreement cannot be resolved at lower levels, communications between the following will be permitted and engaged in, in good faith on an expedited basis: Between a responsible senior officer with settlement authority of Licensor and a responsible manager with settlement authority of Licensee; and, if not resolved by them, between such persons' superiors, if any. If either Licensor or Licensee reorganizes or changes titles, the equivalent person for such Party will perform the above functions.

I. Except for disputes subject to the Referee procedure set forth herein, if a dispute arising under this Agreement is not resolved by the intercompany communications in Section H within forty-five (45) days, the dispute will be resolved in a mediation process at a mutually agreeable location in the venue where the poles subject to the dispute are located. In the event that such dispute is not resolved within ninety (90) calendar days following the first day of mediation, either Party may initiate litigation. The foregoing obligations to engage in intercompany communications and mediation are an essential and material part of this Agreement and ones that are legally binding upon them; in case of a failure of either party to follow the foregoing dispute resolution process, the other may seek specific enforcement of such obligation in any courts having jurisdiction of this Agreement.

## **ARTICLE 22 – TERM OF AGREEMENT**

A. This Agreement will continue in full force and effect for ten (10) years from the Effective Date (Initial Term), and will automatically renew for 5 year terms thereafter unless terminated in accordance herewith. Either Party may terminate the Agreement by giving to the other Party one (1) years' notice in writing of intention to terminate the Agreement one (1) year prior to the end of the Initial Term. Notwithstanding the foregoing, this Agreement will continue in full force and effect for all existing Attachments during any negotiations of the Parties for a subsequent agreement.

B. Upon final termination of this Agreement in accordance with any of its terms, Licensee will, within one-hundred eighty (180) days, remove all its Attachments from all Poles. If not so removed, Licensor will have the right to remove and dispose of all of Licensee's Attachments without any liability or accounting therefore. Licensee will reimburse Licensor for any and all costs incurred by Licensor in the removal of Licensee's Attachments as detailed above. In the event that Licensee has not reimbursed Licensor within sixty (60) days of invoicing following Licensor's removal of said Attachments, then Licensor may pursue one or more of the remedies contained in Article 14, including making demand on the Security Instrument described in Article 25.

C. Termination of this Agreement will not relieve either Party from fulfilling any and all of its obligations that accrued while the Agreement was in effect.

D. During the term of this Agreement or upon termination of this Agreement, each Party will have reasonable access to those portions of the other Party's books, construction standards, and records, as may be necessary to resolve a material issue or concern regarding the other Party's compliance with its obligations under this Agreement. Such access will be granted upon reasonable notice and only during regular business hours.



## **ARTICLE 23 – EXISTING CONTRACTS**

All existing joint use or pole attachment license agreements between the Parties, and all amendments thereto are by mutual consent hereby abrogated and superseded by this Agreement except with respect to amounts owed, late payment penalties and interest and remedies available for collection of such amounts by either party under any such existing agreements.

Nothing in the foregoing will preclude the Parties to this Agreement from entering such supplemental operating routines or working practices as they mutually agree in writing to be necessary or desirable to effectively administer the provisions of this Agreement.

## **ARTICLE 24 – LICENSOR SYSTEM FINANCING OR SALE OF SYSTEM**

This Agreement and any amendment thereof will be effective subject to the condition that, during any period in which the Licensor has outstanding debt or other financing obligations respecting its Poles or its electric distribution system, this Agreement will be subject to the terms and conditions related to such financing. Licensor, without the consent of the Licensee, may enter into or issue debt or other financing obligations from time to time related to its Poles or its electric distribution system with terms and conditions, including covenants that affect Licensee's rights hereunder, that are reasonably required by the counterparties to such transactions or the purchasers of such debt or other financing obligations. Licensor, without the consent of the Licensee, may at any time sell or otherwise transfer ownership of all or any part of its Pole or electric distribution system, and in conjunction therewith, may terminate this Agreement or assign it to the purchaser or transferee in whole or in part.

## **ARTICLE 25 – LIABILITY AND INDEMNIFICATION**

A. Except as set forth below, Licensee assumes sole responsibility for all injuries and damages caused, or claimed to have been caused, by Licensee, its employees, agents, representatives or contractors. Notwithstanding the foregoing, Licensee will have no liability to the Licensor for injuries and damages (a) caused by, through or as a result of the negligence of the Licensor; (b) caused by, through or as a result of the wanton misconduct of the Licensor; or (c) caused by, through or as a result of the facilities or activities of any third party (or parties) attachers whose cables, wires, appliances, equipment or facilities are attached to the same Poles as Licensee's cables, wires, appliances, equipment or facilities.

B. Accordingly, without limiting the effect of the provision of the immediately preceding paragraph, and except as set forth below, Licensee expressly agrees to indemnify, defend and save harmless the Licensor, its governing body, officers, employees, agents, representatives and contractors from all claims, demands, actions, judgments, loss, costs and expenses (collectively, "Claims") caused or claimed to have been caused by, Licensee, its employees, agents, representatives or contractors, including with respect to (a) damage to or loss of property (including but not limited to property of the Licensor or Licensee); (b) injuries or death to persons (including but not limited to injury to or death of any Licensee employees, contractors or agents, or members of the public); (c) any interference with the television or radio reception of, or with the transmission or receipt of telecommunications by, any person which may be occasioned by the installation or operation of Licensee's cables, wires, appliances, equipment or facilities; (d) any injuries sustained and/or occupational diseases contracted by any of the Licensee's employees, contractors or agents of such nature and arising

under such circumstances as to create liability therefore by Licensee or the Licensor under any applicable Worker's Compensation law, including also all claims and causes of actions of any character which any such contractors, employees, the employers of such employees or contractors, and all persons or concerns claiming by, under or through them or either of them may have or claim to have against the Licensor resulting from or in any manner growing out of any such injuries sustained or occupational diseases contracted; it being understood, however, that Licensee will have no liability to the Licensor for injuries and damages (a) caused by, through or as a result of the negligence of the Licensor; (b) caused by, through or as a result of the wanton misconduct of the Licensor; or (c) caused by, through or as a result of the facilities or activities of any third party (or parties) whose cables, wires, or facilities are attached to the same Poles as Licensee's cables, wires, or facilities. In any matter in which Licensee will be required to indemnify the Licensor hereunder, Licensee will control the defense of such matter in all respects, and the Licensor may participate, at its sole cost, in such defense. The Licensor will not settle or compromise any matter in which Licensee is required to indemnify the Licensor without the prior consent of Licensee.

C. To the extent permitted by law, the Licensor agrees to assume liability and be responsible for the payment of any sum or sums of money to any persons whomsoever on account of any Claims arising or claimed to have arisen by, through or as a result of the Licensor's negligent acts or omissions or the Licensor's intentional or wanton misconduct. Licensor will have no liability to the Licensee for injuries and damages (a) caused by, through or as a result of the negligence of the Licensee or its contractors or agents; or (b) caused through or as a result of the wanton misconduct of the Licensee or any of its contractors, agents, representatives or assignees. Nothing contained herein will constitute a waiver of the defense of sovereign immunity in favor of the Licensor.

D. Insurance. In the event Licensee's franchise agreement requires Licensee to insure the franchise authority, the Insurance requirements set forth in Article 25.E herein will not apply to Licensee.

E. In the event Licensee is not required to insure the franchise authority, pursuant to the franchise agreement, Licensee, and any contractors of Licensee while working hereunder, will contract for and maintain in effect throughout the period during which Licensee maintains Attachments on any Poles insurance that meets the amounts set forth in subsections (1) through (3) below. Failure to provide and maintain the required insurance coverage will constitute a Default under this Agreement, in which event Licensor will have the right to pursue any and all of remedies set forth in this Agreement.

1. Worker's Compensation insurance meeting statutory requirements, covering all employees of Licensee who will perform any work on Poles or property owned or controlled by Licensor, including easements and rights-of-way, whether or not such insurance is required by law. If any employee is not subject to the Worker's Compensation laws of the state wherein work is performed, Licensee will extend said insurance to such employee as though said employee were subject to such laws.

2. Commercial general liability insurance covering all operations under this Agreement, including erection, installation, maintenance, Rearrangement and removal of Licensee's Attachments, for bodily injury including death and for property damage of \$2,000,000 per occurrence and in the aggregate and \$2,000,000 products and completed operations aggregate.

3. Automobile liability insurance including self-propelled vehicles which may be used in connection with this Agreement, whether owned, non-owned, or hired, with combined single limit for bodily injury and property damage of \$1,000,000 for each accident.

4. The policies required hereunder will be and issued by such carrier will rated at least V-AII by AM Best.

(a) Licensor, its governing body, officers, employees, and agents will be included as additional insured on each required general and auto liability policy only with respect to liability arising from Licensee's operation in conjunction with this Agreement; and

(b) To the extent allowed by law, Licensee agrees to release and will require its insurers (by policy endorsement if needed) to waive their rights of subrogation against Licensor, its governing body, officers, employees, and agents for loss under the policies of insurance described herein; and

(c) Licensee will furnish Licensor certificates evidencing such insurance within thirty (30) days of the Effective Date of this Agreement and will provide Licensor with copies of any renewal certificates promptly after they become available.

(d) Notwithstanding the above, if Licensee is authorized to operate as a self-insured entity under the laws of the State of Georgia, Licensee may provide self-insurance to meet any of the requirements of this Article 25.E, upon terms and conditions satisfactory to Licensor.

F. SECURITY INSTRUMENT. Licensee will furnish and maintain throughout the term of this Agreement, and thereafter until all of the obligations of Licensee have been fully performed, a bond or other security instrument ("Security Instrument") satisfactory in form and content to Licensor in substitution therefore, to guarantee the payment of any sums which may become due to Licensor or an Licensor Agent for Pole Attachment Rental Fees, inspections, inventories, Make Ready Costs, Unauthorized Attachment Fees, for work performed for the benefit of Licensee under this Agreement, including the removal of Attachments upon termination of this Agreement, for any expense that may be incurred by Licensor or an Licensor agent because of any Default of Licensee, or for any other expense that is to be borne by Licensee under this Agreement. The amount of said Security Instrument, which amount will be maintained throughout the term of the Agreement and thereafter until all of the obligations of Licensee have been fully performed, will be equal to ten thousand US dollars (\$10,000), or twenty-five dollars (\$25) per Attachment, whichever is larger. The amount of the Security Instrument may, in Licensor's discretion, be adjusted if Licensee purchases, acquires, or obtains a controlling interest in additional broadband or other facilities within Licensor's service territory not currently covered by this Agreement which results in a significant increase in the number of Attachments. Any such adjustment will not exceed twenty-five dollars (\$25) per new Attachment. Failure to provide and maintain the aforementioned Security Instrument will be deemed a Default under this Agreement, in which event Licensor will have the right to pursue any and all remedies set forth in this Agreement and at law or equity. The furnishing of such Security Instrument will not affect, limit, diminish or otherwise reduce any obligations of Licensee under this Agreement.

G. Following the completion of the Initial Safety Inspection, the correction of the identified violations, and if the Licensee is in material compliance with all other terms and conditions of the Agreement, the amount of the Security Instrument will be adjusted annually to an amount not to exceed the last annual Pole rental invoice received by the Licensee.

#### **ARTICLE 26 - COMPLIANCE WITH LAWS; CHANGE OF LAW**

A. Applicable Law. Both Parties will comply with all applicable laws and regulations.

B. Change of Law. In the event that any legislative, regulatory, judicial, or other action affects the rights or obligations of the Parties, or establishes rates, terms or conditions for the construction, operation, maintenance, repair or replacement of small cells on city infrastructure or in the right of way, that differ, in any material respect from the terms of this Agreement ("New Law"), then either Party may, upon thirty (30) days written Notice, require that the terms of this Agreement be renegotiated to conform to the New Law. Such conformed terms will then apply on a going forward basis for all existing and new small cell installations, unless the New Law requires retroactive application, in which case such new terms will apply retroactively, as required by the New Law. In the event that the Parties are unable to agree upon new terms within 90 days after Notice, then the rates contained in the New Law will apply from the 90<sup>th</sup> day forward until the negotiations are completed, or a Party obtains a ruling regarding the appropriate conforming terms from a commission or court of competent jurisdiction.

#### **ARTICLE 26 – CONSTRUCTION**

This Agreement was drafted by all Parties hereto and is not to be construed against any party. Neither the negotiations of the language of this Agreement nor any prior drafts of this Agreement or the inclusion or exclusion of any language from prior drafts will be admissible or probative as to the meaning of this Agreement.

#### **ARTICLE 27 – REMEDIES CUMULATIVE**

Unless otherwise provided in this Agreement, all remedies set forth in this Agreement are cumulative and in addition to any other remedies that may be available herein or at law or in equity, if any.

#### **ARTICLE 28 – MISCELLANEOUS**

A. Counterparts. This Agreement may be executed in multiple counterparts, and any one of such counterparts will be considered an original hereof.

B. Entire Agreement; Prior Agreements; Integration. This Agreement and its Exhibits set forth the entire understanding and agreement of the parties as to the subject matter herein, which is the attachment of small cell wireless antenna and equipment to poles. No other prior verbal or written agreements or understandings by and between the parties related to the subject matter contained herein will be effective and are hereby abrogated by, superseded by, or integrated into this Agreement. In the event of a conflict of any term and condition or provision among this Agreement, its Exhibits, and the Attachment permits, the following will

control in order of precedence: This Agreement; Exhibits to this Agreement; any Ordinances currently in effect; and Attachment Permits.

C. Severability. In case any one or more of the provisions of this Agreement will for any reason be held to be illegal or invalid by a court of competent jurisdiction, it is the intention of each of the Parties hereto that such illegality or invalidity will not affect any other provision hereof, but this Agreement will be construed and enforced as if such illegal or invalid provision had not been contained herein, and this Agreement will be construed to adopt, but not to enlarge upon, all the applicable provisions of applicable law, and, if any provisions hereof conflict with any provision of applicable law, the latter as in effect and as interpreted by the applicable courts will prevail in lieu of any provision hereof in conflict or not in harmony therewith.

D. Force Majeure. As used in this Agreement "Force Majeure Event" means any act or event whether foreseen or unforeseen, that meets all of the following tests:

1. The act or event prevents a party (the "Nonperforming Party"), in whole or in part, from performing its obligations under this Agreement or satisfying any conditions to the other party's obligations under this Agreement.
2. The act or event is beyond the reasonable control of and not the fault of the Nonperforming Party.
3. The Nonperforming Party has been unable to avoid or overcome the act or event by the exercise of due diligence.

E. Despite the preceding definition of a Force Majeure Event, a Force Majeure Event excludes economic hardship, changes in market conditions or insufficiency of funds.

F. In the event of a Force Majeure Event affecting Licensor's Poles, the Parties' obligations hereunder are suspended for a period of time reasonably appropriate to the Force Majeure Event to the extent performance hereunder adversely affected.

G. Modifications; Amendments. No amendment or modification of this Agreement will be binding unless executed in writing by the Parties hereto.

H. Governing Law. Except to the extent that federal law, regulations, and/or agency orders control any aspect of this Agreement, the validity of this Agreement, the construction and enforcement of its terms, and the interpretation of the rights and duties of the parties will be governed by the laws of the State in which the subject poles are located.

I. Hazardous Materials. Licensor agrees to comply with applicable state and federal environmental laws and regulations including those governing hazardous materials and waste, and, warrants that it administers and enforces policies, practices and procedures sufficient to achieve such compliance with respect to its facilities.

IN WITNESS WHEREOF the Parties hereto have caused these presents to be executed in two counterparts, each of which will be deemed an original, and their corporate seals to be affixed thereto by their respective officers thereunto duly authorized, as of the Effective Date.

LICENSOR  
City of Oxford

By:   
Name:  
Its:

Attest:

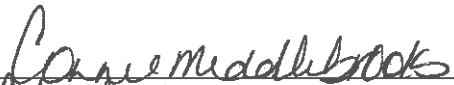
By:   
Its: *city clerk*

[SEAL]

LICENSEE

NEW CINGULAR WIRELESS PCS, LLC

By: AT&T Mobility Corporation  
Its: Manager

By: \_\_\_\_\_  
Name:  
Its:

Attest:

By: \_\_\_\_\_  
Its:

[SEAL]

### Exhibit 1 – Application to Attach

Licensee hereby requests permission pursuant to its Addendum to Pole Attachment License Agreement for Attachment of Wireless Facilities to make new Attachment(s) to Pole as shown on the attached construction plans and drawings. The attached plans and drawings show the Pole Licensee desires to attach to, the number and character of Attachments existing and proposed, any Rearrangements requested with respect to existing Attachments, any relocations or replacements of existing Pole requested, the heights of all points of attachment, all mid-span clearances, any new Pole placement requested, pole loading analysis report, and completed Radio Frequency Emission Certificate. Should additional information be required by the Electric Provider for verification of compliance with the NESC or other applicable standards, the Licensee will provide such information. The table below provides detailed information regarding this request.

<b>LICENSEE NAME:</b>			
Project		Proposed Attachments	
Request #		New	Modified
Request		Remove	in.
Name		Power Space	in.
Phone		Communications Space	in.
E-Mail		Common Space	in.
Estimated Construction Dates			
Start		Finish	
Signature			
<b>Include Attachments above the top of the Pole and in the Communications Worker's Safety Zone</b>			

Please advise Licensee as to whether or not these Wireless Facilities Attachments will be permitted and if necessary provide an estimate for any additional costs that Licensee may be required to pay as Make Ready Work. If Make Ready Work is required, upon receipt of Electric Provider supplied Make Ready Estimate, the Licensee will provide notice to Electric Provider of either approval of the cost estimate or that Licensee will not undertake to make these Attachments. Upon receipt by Electric Provider of Licensee's notice of estimate approval of Make Ready Costs, the Electric Provider will proceed with Make Ready Work.

<b>ELECTRIC PROVIDER</b>			
Response Date		Make Ready Construction Required?	Yes
Name			No
Phone		Make Ready Construction Estimate	\$
Email			
Signature		Permit #	
Request	Approved	Reason for Denial:	
	Denied		

Capitalized terms used in this request, but not defined, have the meaning set forth in the applicable Addendum to Pole Attachment License Agreement for Attachment of Wireless Facilities or Pole Attachment License Agreement.



## Exhibit 2 – Annual Attachment Fee

### Wireless Facilities Attachments

The Adjustment Payments for Wireless Facilities will be calculated on a “per foot” basis. For purposes of calculating such Adjustment Payments for Wireless Facilities, every twelve inches (12”) of vertical space, or any part thereof, of each Wireless Facility component which is attached to the Pole, exclusive of riser and/or conduit, regardless of placement location, will constitute one (1) attachment. For example, if Licensee’s Wireless Facility takes up thirty inches (30”) of vertical space on the Pole, such Wireless Facility will be considered as three (3) attachments for purposes of determining the Adjustment Payment for such Wireless Facility.

Term	Rental Fee	Invoice Date
Jan. 1, 2019 – Dec. 31, 2019	\$16.50	Dec. 1, 2019
Jan. 1, 2020 – Dec. 31, 2020	\$16.50	Dec. 1, 2019

For years beginning 2021, the annual Rental Fee per Attachment will be adjusted by applying the annual change for account 364 for the South Atlantic Region from the latest version of the Handy Whitman Index.

### Exhibit 3 Radio Frequency Emissions Certification

The Effective Isotropic Radiated Power ("EIRP") of the Wireless Facilities will comply with Part 15 of the FCC Rules and radio frequency exposure from the Wireless Facilities will comply with Sections 1.1307(b) and 1.1310 of the FCC's Rules, as clarified by the FCC's *OET Bulletin 65*, latest revisions ("RF Exposure Rules").

Will the Wireless Facilities that are the subject of the accompanying Application to Attach, dated \_\_\_\_\_, as installed, comply fully with the RF Exposure Rules for General Population/Uncontrolled Environments as specified by the Federal Communications Commission at 47 C.F.R. §§1.1307(b) and 1.1310 (or its successor regulation) and clarified by the FCC's *OET Bulletin 65*, latest revision, ?

Yes

No

#### Certification:

I certify that: (i) I am a qualified/certified RF Engineer with experience regarding radio frequency emissions; (ii) I have performed the analysis specified in 47 C.F.R. § 1.1310 of the FCC's rules and *OET Bulletin 65* for each and every one of the Wireless Facilities Attachments covered in the Request for Permission to Attach Wireless Facilities, dated \_\_\_\_\_, and (iii) the answer given above is true.

\_\_\_\_\_  
Signature

\_\_\_\_\_  
Print Name

\_\_\_\_\_  
License Number

**Exhibit 4 – Approved Contractors**

**Exhibit 5 – ECG Specifications**

[ATTACH SECTION 5 “JOINT USE AND CLEARANCES” OF THE  
ELECTRIC CITIES OF GEORGIA INC. CONSTRUCTION ASSEMBLY SPECIFICATIONS]

---

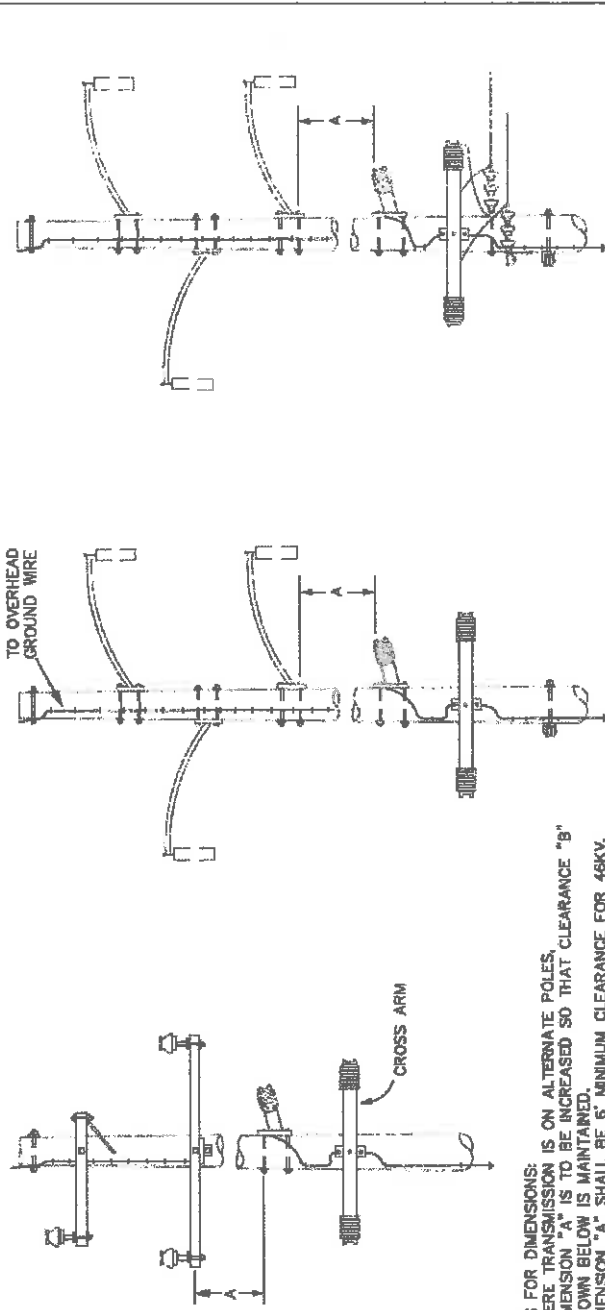

NOTES FOR DIMENSIONS:  
 1. WHERE TRANSMISSION IS ON ALTERNATE POLES, DIMENSION "A" IS TO BE INCREASED SO THAT CLEARANCE "B" SHOWN BELOW IS MAINTAINED.  
 2. DIMENSION "A" SHALL BE 6" MINIMUM CLEARANCE FOR 46KV.  
 DIMENSION "A" SHALL BE 8" MINIMUM CLEARANCE FOR 69KV.  
 DIMENSION "A" SHALL BE 10" MINIMUM CLEARANCE FOR 115KV & 230KV.  
 3. DIMENSION "B" SHALL BE 11" MINIMUM CLEARANCE AT 120' FAHR. FOR 115KV AND BELOW.  
 DIMENSION "B" SHALL BE 13' MINIMUM CLEARANCE AT 120' FAHR. FOR 230KV.

GENERAL NOTES:  
 1. ALL HARDWARE SHALL BE BONDED TO TRANSMISSION GROUND.  
 2. BOND NEUTRAL TO TRANSMISSION GROUND. DO NOT INSTALL ADDITIONAL GROUND LEAD.

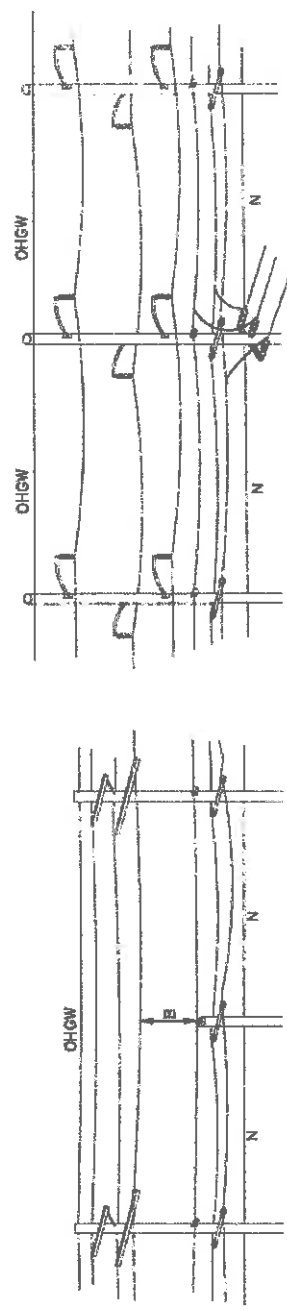

**JOINT TRANSMISSION & DISTRIBUTION**



REVISIONS JULY, 2001  
 JANUARY, 2007

**JU&C1**

DATE: OCTOBER, 1992

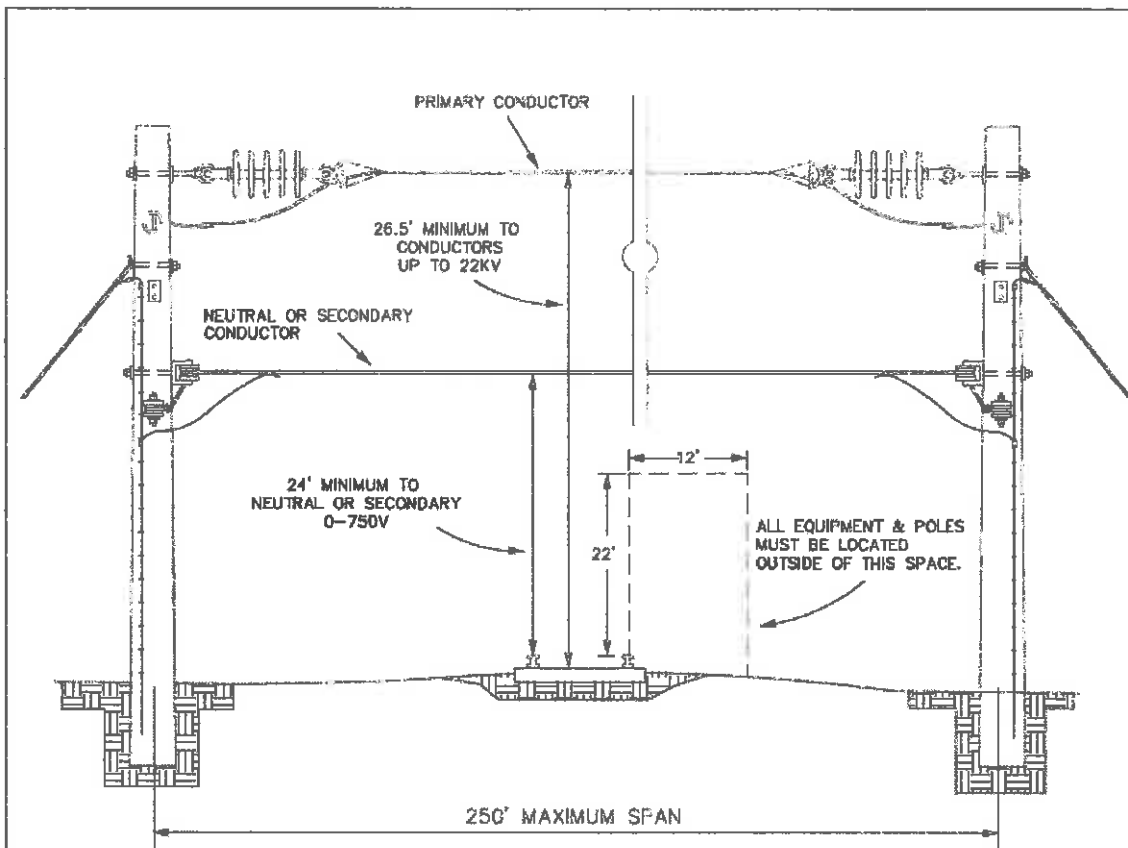

1. IF SPAN LENGTH EXCEEDS 250 FEET, CONDUCTOR CLEARANCE IS TO BE INCREASED 0.3 FEET FOR EACH 10 FEET SPAN LENGTH IN EXCESS OF THE 250 FEET.
2. CROSSINGS SHOULD BE MADE ON A COMMON SUPPORT STRUCTURE WHERE PRACTICAL. COOPERATION BETWEEN THE PARTIES CONCERNED SHALL PREVAIL PROPER CLEARANCES.
3. EXCEPTIONS TO 12' HORIZONTAL SIDE CLEARANCE:
  - (a) A CLEARANCE OF NOT LESS THAN 8 FEET MAY BE ALLOWED WHERE NECESSARY IF THE SUPPORTING STRUCTURE IS NOT THE CONTROLLING OBSTRUCTION, PROVIDED SUFFICIENT SPACE FOR A DRIVEWAY IS LEFT WHERE CARS ARE LOADED.
  - (b) WHERE NECESSARY TO PROVIDE SAFE OPERATING CONDITIONS WHICH REQUIRE AN UNINTERRUPTED VIEW OF SIGNALS, SIGNS, ETC. ALONG TRACKS THE PARTIES CONCERNED SHALL COOPERATE IN LOCATING STRUCTURES TO PROVIDE THE NECESSARY CLEARANCE.
  - (c) AT INDUSTRIAL SIDINGS, A CLEARANCE OF NOT LESS THAN 8 FEET SHALL BE PERMITTED, PROVIDED SUFFICIENT SPACE IS LEFT WHERE CARS CAN BE LOADED OR UNLOADED.

## **RAILROAD CROSSING CONSTRUCTION CLEARANCES**



DATE: OCTOBER, 1992

REVISIONS JULY, 2001

JANUARY, 2007

**JU&C2**

NOTES:

1. THIS 40" CLEARANCE ALSO APPLIES TO THE CLOSEST METAL PORTION OF ANY ONE SPOOL OR FOUR SPOOL RACKS.
2. IF THE BOTTOM OF THE CONDUCTOR BRACKET IS LESS THAN 10" FROM THE BOTTOM OF THE TRANSFORMER TANK, THEN THE 40" REQUIRED SPACE FROM THE BOTTOM OF THE CONDUCTOR SHALL SUPERCEDE THE 30" SPACE FROM THE BOTTOM OF THE TRANSFORMER TANK.
3. MESSENGER STRAND SHALL BE BONDED TO THE POLE GROUND, IF PRESENT.

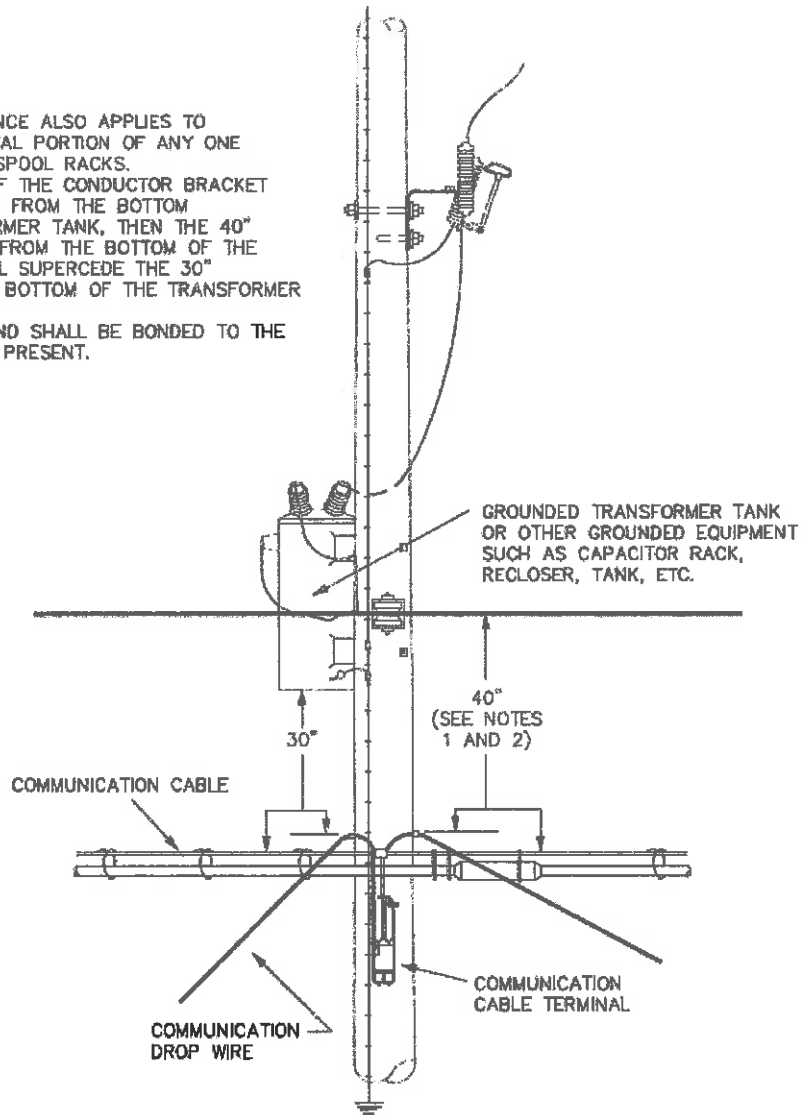

**TRANSFORMER POLE**



REVISIONS JULY, 2001

DATE: OCTOBER, 1992

**JU&C3**

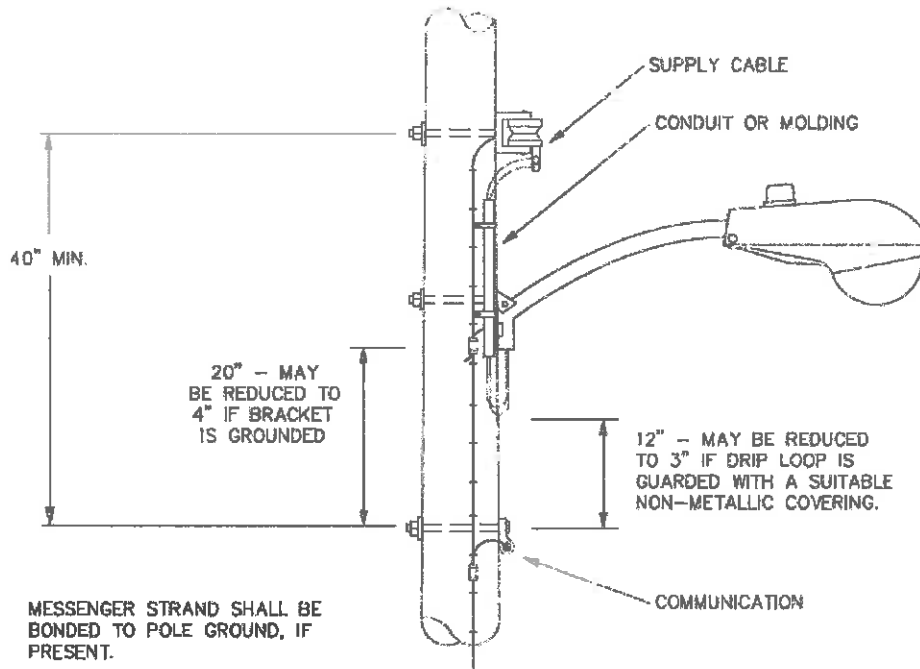

NOTES:

- 1.) LIGHT FIXTURE SHOWN IS SYMBOLIC ONLY. CLEARANCES SHOWN ARE APPLICABLE TO ANY TYPE FIXTURE USED.
- 2.) LOWEST PART OF LUMINAIRE SHALL BE NOT LESS THAN 15' OVER ROADS, STREETS, PARKING LOTS, OR ALLEYS.

**C.A.T.V., TELEPHONE, OTHER  
SEPARATION FROM LUMINAIRES**



REVISIONS JULY, 2002

DATE: OCTOBER, 1992

**JU&C4**



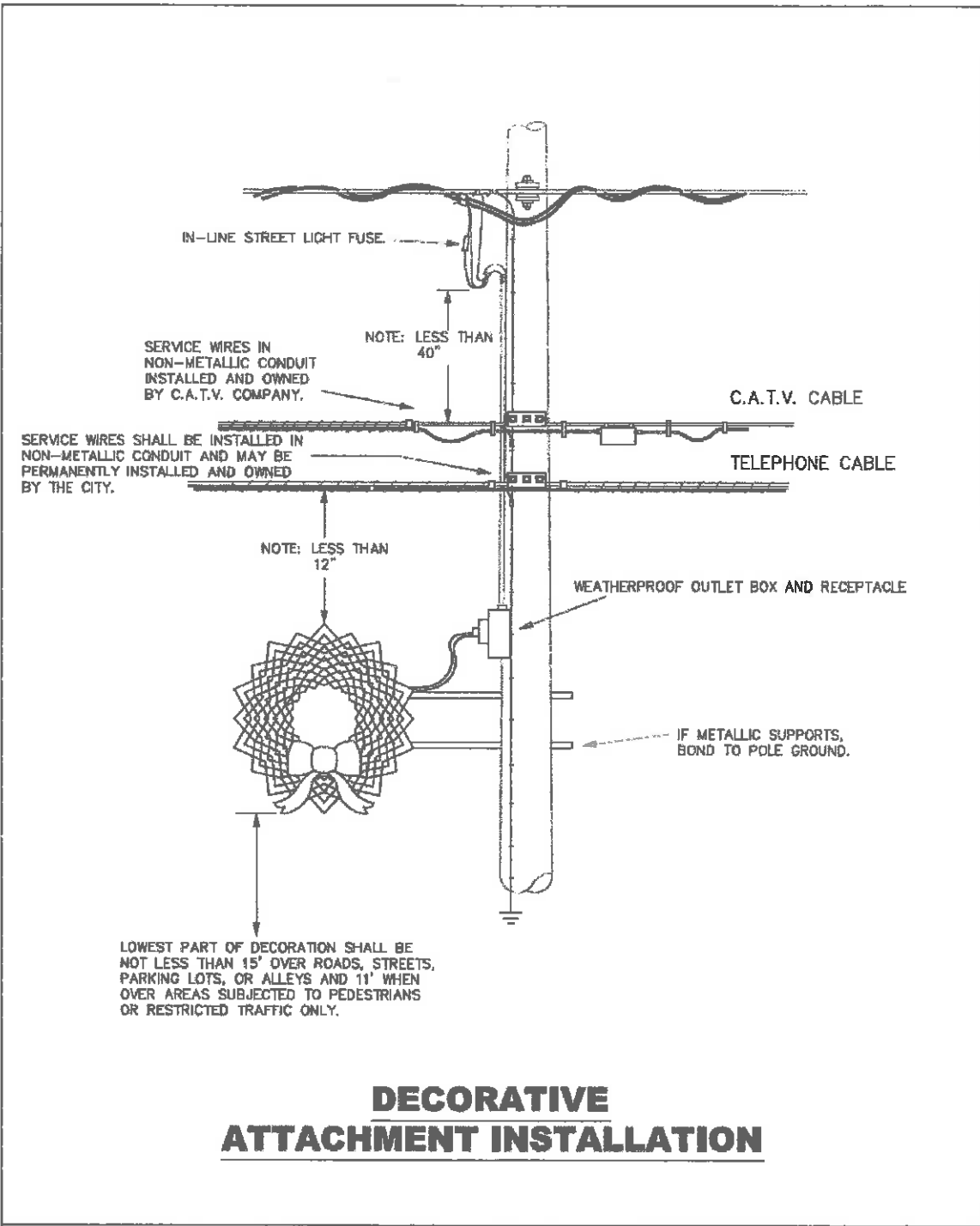

## DECORATIVE ATTACHMENT INSTALLATION

 <p style="font-size: small;">electric utility of georgia</p>	REVISIONS JULY, 2001 <hr/> <hr/>	<b>JU&amp;C5</b>
DATE: OCTOBER, 1992		

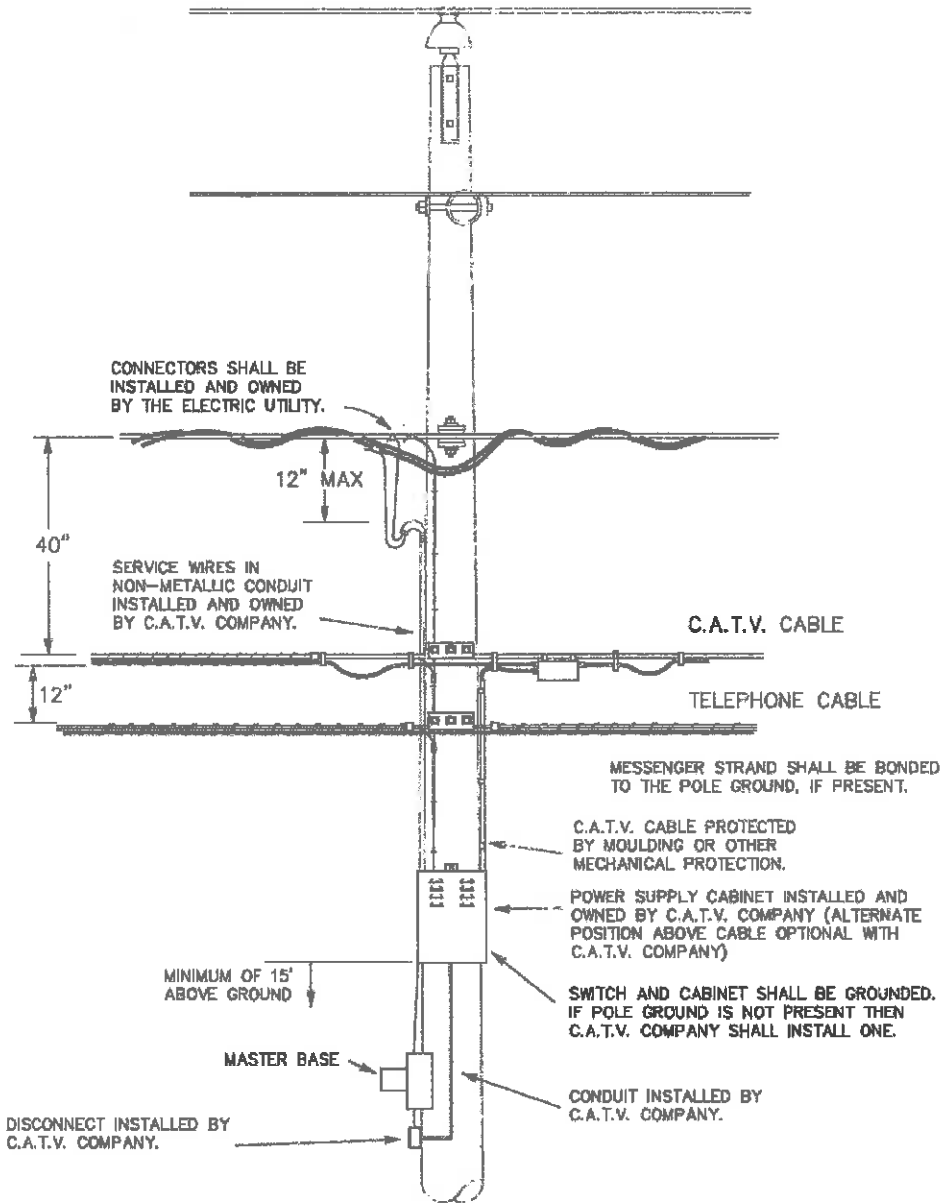

## **COMMUNICATION/SIGNAL TYPE ATTACHMENT C.A.T.V. POWER SUPPLY INSTALLATION**



DATE: OCTOBER, 1992

REVISIONS JULY, 2001

**JU&C6**

**\*COMMUNICATION/SIGNAL TYPE ATTACHMENT**

- TELEPHONE CABLE
- C.A.T.V. CABLE
- ALARM CABLE (FIRE, POLICE, WATER TOWER LEVEL, ETC.)
- TRAFFIC SIGNAL CONTROL CABLE
- TELEGRAPH CABLE
- PUBLIC OR PRIVATE COMMUNICATION CABLE

**NOTES:**

- 1.) WHEN C.A.T.V. AND TELEPHONE ARE ATTACHED TO POLE, C.A.T.V.'S PREFERRED POSITION IS ABOVE TELEPHONE (12" MIN.). IF OTHER COMMUNICATION/SIGNAL TYPE CABLES ARE ATTACHED TO POLE WITH C.A.T.V. AND/OR TELEPHONE, THEIR POSITION SHALL BE MUTUALLY AGREED UPON.
- 2.) 12" MIN. SPACING SHOULD BE MAINTAINED BETWEEN CABLES. C.A.T.V. AND TELEPHONE DROPS CAN BE LESS THAN 12" FROM OTHER CABLES. DROPS SHALL BE 40" BELOW POWER NEUTRAL OR SECONDARY AT POLE.
- 3.) ALL CABLES SHALL BE ON SAME SIDE OF POLE.
- 4.) MESSENGER STRAND SHALL BE BONDED TO POLE GROUND, IF PRESENT.

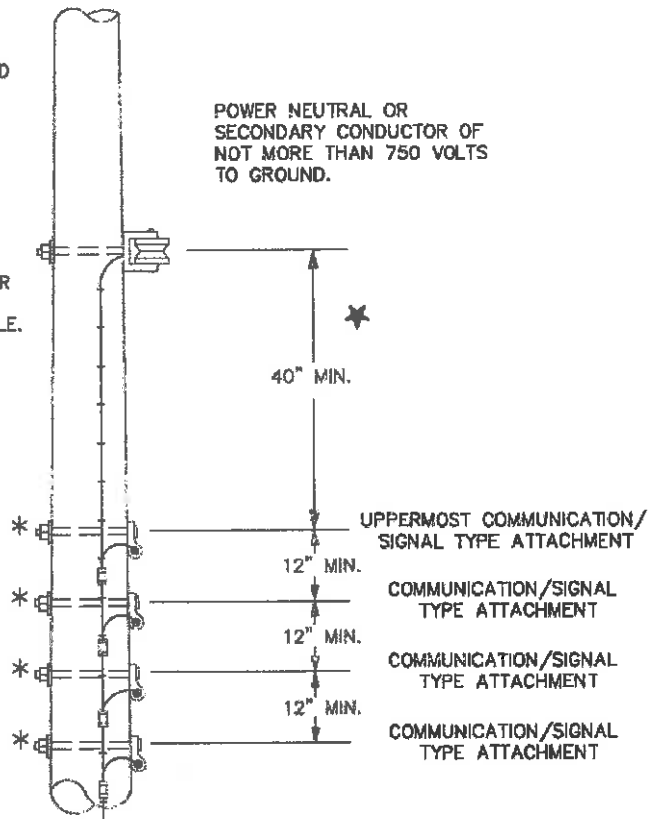

\* FOR SUPPLY NEUTRAL ONLY, THIS MAY BE REDUCED TO 30".

**MULTIPLE COMMUNICATION/SIGNAL TYPE ATTACHMENT**



REVISIONS JULY, 2001

**JU&C7**

DATE: OCTOBER, 1992

**FOOTNOTES TABLE 1:**

1. Where the height of a building or other installation does not permit service drops to meet these values, the clearances over residential driveways only may be reduced to the following:

	<u>FEET:</u>
a. Service drops limited to 300 V to ground	12.5
b. Service drip loops limited to 300 V to ground	10.5
c. Service limited to 150 V to ground	12.0
d. Drip loops only of service limited to 150 V to ground	10.0

2. Where the height of a building or other installation does not permit service drops to meet these values, the clearances may be reduced to the following:

	<u>FEET:</u>
a. Service drops, including drip loops, limited to 300 V to ground	10.5
b. Service drops, including drip loops, limited to 150 V to ground	10.0

3. Spaces and ways subject to pedestrians or restricted traffic only are those areas where equestrians, vehicles, or other mobile units, exceeding 8ft. in height, are prohibited by regulation or permanent terrain configurations or are otherwise not normally encountered or reasonably anticipated.

4. Where a supply or communication line along a road is located relative to fences, ditches, embankments, etc., so that the ground under the line would not be expected to be traveled except by pedestrians, the clearance may be reduced to the following values:

	<u>FEET:</u>
a. Insulated communications cables, neutrals, guys, and multiplex supply cables limited to 150 V to ground	9.5
b. Multiplex supply cables limited to 300 V to ground	12.5

5. This clearance may be reduced to 13 ft. for communication conductors and guys.

6. Where this construction crosses over or runs along alleys, driveways, or parking lots, this clearance may be reduced to 15 ft.

7. For controlled impoundments, the surface area and corresponding clearances shall be based upon the design high water level. For other waters, the service area shall be that enclosed by its annual high water mark, and clearances shall be based on the normal flood level. The clearance over rivers, streams, and canals shall be based upon the largest surface area of any 1 mi. long segment, which includes the crossing. The clearance over a canal, river, or stream normally used to provide access for sailboats to a larger body of water shall be the same as that required for the larger body of water.

9. For the purpose of this rule, trucks are defined as any vehicle exceeding 8 ft. in height. Areas not subject to truck traffic are areas where truck traffic is not normally encountered or not reasonably anticipated.

10. Communication cables and conductors may have a clearance of 15 ft. where poles are back of curbs or other deterrents to vehicular traffic.

Note: Footnote 8 and 11 were intentionally omitted

FOOTNOTES TABLE 1: (cont'd)

12. Where the U.S. Army Corps of Engineers, or the state or the surrogate thereof has issued a crossing permit, clearance of that permit shall govern.
13. For controlled impoundments, the surface area and corresponding clearance shall be based upon the design high water level. For other waters, the surface area shall be that enclosed by its annual high water mark, and clearances shall be based upon the largest surface area of any one mile long segment that includes the crossing. The clearance of a canal, river or stream normally used to provide access for sailboats to a larger body of water shall be the same as required for the larger body of water.
14. Where an over water obstruction restricts vessel height to less than the following:

Surface Area (Acres)	Reference Vessel Height (Feet)
less than 20	16
20 to 200	24
200 to 2000	30
over 2000	36

The required clearances may be reduced by the difference between the reference vessel height given above and the over water obstruction height, except that the reduced clearance shall not be less than that required for the surface area on the line crossing side of the obstruction.

The vertical clearance shall be maintained with the conductor at final sag and at the following condition whichever results in the greater vertical sag:

1. 32° F, no wind, with radial thickness of ice of 1/4 inch for medium loading and no ice for light loading.
- Or
2. The maximum conductor for which the line is designed to operate, if greater than 120° F.(120° F for all neutrals)

Note:

All clearances shown are design clearances under specified conditions, not measured clearances under ambient conditions.

<b>VOLTAGES ARE PHASE TO GROUND FOR EFFECTIVELY GROUNDED CIRCUITS</b>				
NATURE OF SURFACE UNDERNEATH WIRES, CONDUCTORS, OR CABLES	INSULATED COMMUNICATION CONDUCTORS AND CABLE MESSengers; GROUNDED GUYS; SYSTEM NEUTRAL  (IN FEET)	DUPLEX, TRIPLEX, & QUADRIplex CABLE WITH GROUNDED GUYS; GROUNDED NEUTRAL 0 - 750 VOLTS  (IN FEET)	OPEN WIRE SECONDARY CONDUCTORS 0 - 750 VOLTS  (IN FEET)	OPEN WIRE CONDUCTORS OVER 750 VOLTS TO 22KV  (IN FEET)
WHERE WIRES, CONDUCTORS, OR CABLE CROSS OVER OR OVERHANG				
1. TRACK RAILS OF RAILROADS.	23.5	24	24.5	26.6
2. ROADS, STREETS, AND OTHER AREAS SUBJECT TO TRUCK TRAFFIC. (SEE NOTE 9.)	15.5	16	16.5	18.5
3. DRIVEWAYS, PARKING LOTS, AND ALLEYS	15.5 (SEE NOTES 1 AND 6)	16 (SEE NOTES 1 AND 6)	16.5 (SEE NOTE 1)	18.5
4. OTHER LAND TRAVERSED BY VEHICLES SUCH AS CULTIVATED, GRAZING, FOREST, ORCHARD, ETC.	15.5	16	16.5	18.5
5. SPACES OR WAYS SUBJECT TO PEDESTRIAN OR RESTRICTED TRAFFIC ONLY. (SEE NOTE 3.)	9.5	12 (SEE NOTE 2)	12.5 (SEE NOTE 1)	14.5
6. WATER AREAS NOT SUITABLE FOR SAILBOATS OR WHERE SAILBOATS ARE PROHIBITED. (SEE NOTE 12.)	14	14.5	15	17
7. A) WATER AREAS (NOT REGULATED BY CORPS OF ENGR.) SUITABLE FOR SAILBOATS, INCLUDING LAKES, PONDS, RESERVOIRS, TIDAL WATERS, RIVERS, STREAMS, AND CANALS WITH AN UNOBSTRUCTED SURFACES AREA OF: A. LESS THAN 20 ACRES B. 20 TO 200 ACRES C. 200 TO 2000 ACRES D. OVER 2000 ACRES (SEE NOTES 12, 13, & 14.)	17.5 25.5 31.5 37.5	18 26 32 38	18.5 26.5 32.5 38.5	20.5 28.5 34.5 40.5
7. B) WATER AREAS REGULATED BY CORPS OF ENGINEERS (SEE NOTE 7)	52	55	55	55
8. PUBLIC OR PRIVATE LAND AND WATER AREAS POSTED FOR RIGGING OR LAUNCHING SAILBOATS.	CLEARANCE ABOVE GROUND SHALL BE 5 FEET GREATER THAN IN 7. ABOVE, FOR THE TYPE OF WATER AREAS SERVED BY THE LAUNCHING SITE.			
WHERE WIRES, CONDUCTOR, OR CABLES RUN ALONG AND WITHIN THE LIMITS OF HIGHWAY OR OTHER ROAD RIGHT-OF-WAY BUT DO NOT OVERHANG THE ROADWAY				
9. ROADS, STREET, OR ALLEYS	15.5 (SEE NOTES 6 AND 10)	15.5 (SEE NOTES 6)	16.5	18.5
10. ROADS IN RURAL DISTRICTS WHERE IT IS UNLIKELY THAT VEHICLES WILL BE CROSSING UNDER THE LINE.	15.5 (SEE NOTES 4 AND 5)	14.0 (SEE NOTES 4)	14.5 (SEE NOTES 4)	16.5

\*ALWAYS REFER TO THE LATEST NESC  
(REFERENCE NESC RULE 232, 2007 EDITION, FOR ADDITIONAL INFORMATION)

## **VERTICAL CLEARANCES OF WIRES, CONDUCTORS, AND CABLES ABOVE GROUND, ROADWAYS, RAILS, OR WATER**

 <small>electric utility of georgia</small>	REVISIONS <u>JULY, 2002</u>	<b>TABLE 1</b>
	DATE: <u>OCTOBER, 1992</u>	

FOOTNOTES TABLE 2:

1. Where a building, sign, chimney, antenna, tank, or other installation does not require maintenance such as painting, washing, changing of sign letters, or other operations which would require persons to work or pass between supply conductors or unguarded rigid live parts and structures, the clearance may be reduced by 2 ft.
3. A roof, balcony, or area is considered readily accessible to pedestrians if the means of access is through a doorway, ramp, window, stairway, or permanently mounted ladder. A permanently mounted ladder is not considered a means of access if its bottom rung is 8 ft. or more from the ground or other permanently installed accessible surface.
4. The required clearances shall be to the closest approach of motorized signs or moving portions of installations.
5. For the purpose of this rule, trucks are defined as any vehicle exceeding 8 ft. in height.
6. This clearance may be reduced to 3 in. for the grounded portions of the guys.
7. Windows not designed to open may have the clearance permitted for the walls and projections.
8. The horizontal clearance shall not be less than 3.5' plus the displacement of the conductor by a 6 lb/ft<sup>2</sup> wind at 60° F, final sag.
9. The horizontal clearance shall not be less than 4.5' plus the displacement of the conductor by a 6 lb/ft<sup>2</sup> wind at 60° F, final sag.
10. Where available space will not permit this value, the clearance may be reduced to 7.0 ft. for conductors limited to 8.7 KV to ground.

Note: Footnote 2 was intentionally omitted.

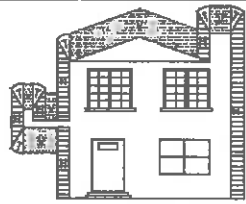

H - HORIZONTAL CLEARANCE  
T - TRANSITIONAL = VERTICAL (ARC)

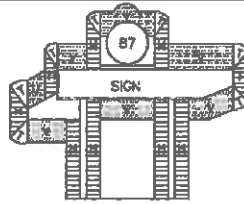

V - VERTICAL CLEARANCE

**VOLTAGES ARE PHASE TO GROUND FOR EFFECTIVELY GROUNDED CIRCUITS**

CLEARANCE FROM:	INSULATED COMMUNICATION CONDUCTORS AND CABLES; MESSENGERS; GROUNDED GUYS; NEUTRAL CONDUCTORS (IN FEET)	MULTIPLEX SUPPLY CABLE 0 - 750 VOLTS (IN FEET)	OPEN WIRE CONDUCTORS 0 - 750 VOLTS (IN FEET)	UNGUARDED RIGID LIVE PARTS, OVER 750 VOLTS TO 22 KILOVOLTS (IN FEET)	OPEN WIRE CONDUCTORS OVER 750 VOLTS TO 22 KILOVOLT (IN FEET)
<b>1. BUILDINGS</b>					
<b>A. HORIZONTAL</b>					
(1) TO WALLS, PROJECTIONS, AND GUARDED WINDOWS.	4.5 (SEE NOTE 6)	5.0 (SEE NOTE 1)	5.5 (SEE NOTE 1 & 8)	7.0 (SEE NOTE 1)	7.5 (SEE NOTE 1,9,&10)
(2) TO UNGUARDED WINDOWS. (SEE NOTE 7)	4.5	5.0	5.5 (SEE NOTE 1 & 8)	7.0	7.5 (SEE NOTE 9 & 10)
(3) TO BALCONIES AND AREA ACCESSIBLE TO PEDESTRIANS. (SEE NOTE 3)	4.5	5.0	5.5 (SEE NOTE 8)	7.0	7.5 (SEE NOTE 9 & 10)
<b>B. VERTICAL</b>					
(1) OVER OR UNDER ROOF OR PROJECTIONS NOT READILY ACCESSIBLE TO PEDESTRIANS. (SEE NOTE 3)	3.0	3.5	10.5	12.0	12.5
(2) OVER OR UNDER BALCONIES AND ROOFS READILY ACCESSIBLE TO PEDESTRIANS. (SEE NOTE 3)	10.5	11.0	11.5	13.0	13.5
(3) OVER ROOFS ACCESSIBLE TO VEHICLES, BUT NOT SUBJECT TO TRUCK TRAFFIC. (SEE NOTE 5)	10.5	11.0	11.5	13.0	13.5
(4) OVER ROOFS ACCESSIBLE TO TRUCK TRAFFIC. (SEE NOTE 5)	15.5	16.0	16.5	18.0	18.5
<b>2. SIGNS, CHIMNEYS, BILLBOARDS, RADIO AND TELEVISION ANTENNAS, TANKS, AND OTHER INSTALLATIONS NOT CLASSIFIED AS BUILDINGS OR BRIDGES.</b>					
<b>A. HORIZONTAL; (SEE NOTE 4)</b>					
(1) READILY ACCESSIBLE	4.5	5.0	5.5	7.0	7.5
(2) NOT READILY ACCESSIBLE	3.0	3.5	5.5 (SEE NOTES 1 & 8)	7.0	7.5 (SEE NOTE 1,9,&10)
<b>B. VERTICAL</b>					
(1) OVER OR UNDER CATWALKS AND OTHER SURFACES UPON WHICH PERSONNEL WALK.	10.5	11.0	11.5	13.0	13.5
(2) OVER OR UNDER OTHER PORTIONS OF SUCH INSTALLATIONS.	3.0	3.5	6.0 (SEE NOTE 1)	7.5	8.0

\*ALWAYS REFER TO THE LATEST NESC  
(REFERENCE NESC RULE 232, 2007 EDITION, FOR ADDITIONAL INFORMATION)

**CLEARANCES OF WIRES, CABLES, AND UNGUARDED RIGID LIVE PARTS ADJACENT BUT NOT ATTACHED TO BUILDINGS AND OTHER INSTALLATIONS EXCEPT BRIDGES**



REVISIONS JULY, 2001

**TABLE 2**

DATE: OCTOBER, 1992



**POLE ATTACHMENT LICENSE AGREEMENT  
FOR DISTRIBUTION POLES**

**BETWEEN**

City of Oxford

**AND**

Verizon Wireless (VAW) LCC D/B/A Verizon Wireless

**TABLE OF CONTENTS**

PREAMBLE ..... 3  
ARTICLE 1 – SCOPE OF AGREEMENT ..... 3  
ARTICLE 2 – EXPLANATION OF TERMS ..... 3  
ARTICLE 3 – SPECIFICATIONS ..... 7  
ARTICLE 4 – ESTABLISHING ATTACHMENTS TO POLES ..... 8  
ARTICLE 5 – RADIO FREQUENCY ..... 11  
ARTICLE 6 – RIGHT OF WAY FOR LICENSEE'S ATTACHMENTS ..... 12  
ARTICLE 7 – MAINTENANCE OF POLES AND ATTACHMENTS ..... 12  
ARTICLE 8 – DIVISION OF COSTS ..... 14  
ARTICLE 9 – INSPECTIONS ..... 15  
ARTICLE 10 – UNAUTHORIZED ATTACHMENTS ..... 17  
ARTICLE 11 – ATTACHMENT COUNTS ..... 17  
ARTICLE 12 – ABANDONMENT OF LICENSED POLES ..... 18  
ARTICLE 14 – DEFAULTS ..... 19  
ARTICLE 15 – RIGHTS OF OTHER PARTIES ..... 20  
ARTICLE 16 – ASSIGNMENT OF RIGHTS ..... 20  
ARTICLE 17 – WAIVER OF TERMS OR CONDITIONS ..... 21  
ARTICLE 18 – PAYMENT OF TAXES ..... 21  
ARTICLE 19 – BILLS AND PAYMENT FOR WORK ..... 21  
ARTICLE 20 – NOTICES ..... 22  
ARTICLE 21 – RESOLUTION OF CERTAIN DISPUTES ..... 23  
ARTICLE 22 – TERM OF AGREEMENT ..... 25  
ARTICLE 23 – EXISTING CONTRACTS ..... 26  
ARTICLE 24 – LICENSOR SYSTEM FINANCING OR SALE OF SYSTEM ..... 26  
ARTICLE 25 – LIABILITY AND INDEMNIFICATION ..... 26  
ARTICLE 26 - COMPLIANCE WITH LAWS; CHANGE OF LAW ..... 29  
ARTICLE 27 – CONSTRUCTION ..... 29  
ARTICLE 28 – REMEDIES CUMULATIVE ..... 30  
ARTICLE 29 – MISCELLANEOUS ..... 30  
[SEAL] ..... 32  
Exhibit 1 – Application to Attach ..... 33  
Exhibit 2 – Annual Attachment Fee ..... 35  
Exhibit 3 - Radio Frequency Emissions Certification ..... 36  
Exhibit 4 – Approved Contractors ..... 37  
Exhibit 5 – ECG Specifications ..... 38

***POLE ATTACHMENT LICENSE AGREEMENT FOR DISTRIBUTION POLES***

**PREAMBLE**

THIS AGREEMENT (“Agreement”), effective as of this 19<sup>th</sup> day of March, 2019 (“Effective Date”), by and between the undersigned municipal corporation of the State of Georgia (the “Licensor”), and Verizon Wireless (VAW) LCC D/B/A Verizon Wireless, a limited liability company organized under the laws of the State of Delaware (the “Licensee”), referred to collectively as “Parties,” and individually as “Party”;

WHEREAS, the Licensor and Licensee desire to enter into a pole attachment license agreement for the use of Licensor’s poles, erected or to be erected within the area in which both Parties render service in the State of Georgia, to be consistent with the terms of this Agreement.

NOW, THEREFORE, in consideration of the premises and the mutual covenants herein contained and other consideration set forth herein the adequacy of which is acknowledged, the Parties hereto for themselves, their successors and assigns do hereby agree to the following terms and conditions:

**ARTICLE 1 – SCOPE OF AGREEMENT**

A. This Agreement shall be in effect in the area in which both of the Parties render service in the State of Georgia, and shall cover all distribution poles now existing or hereafter erected in the above territory when said poles are brought under this Agreement in accordance with the procedure hereinafter provided.

B. Licensor reserves the right for good cause to exclude from use any of its facilities for objective reasons of safety, reliability, capacity, and generally applicable engineering standards.

**ARTICLE 2 – EXPLANATION OF TERMS**

A. For the purpose of this Agreement, the following terms shall have the following meanings:

“Above the Communications Space” means the space above the Communications Space, as defined below, but not limited to the Power Space and space above the Power Space.

“Actual Costs” means all costs, including, but not limited to, the costs of materials, labor, engineering, supervision, overheads, transportation and contractor fees, when used in lieu of Licensor labor. Licensor Actual Costs shall be verifiably comparable to the cost Licensor pays for similar work to its own facilities.

“Affiliate” means any entity that controls, is controlled by, or is under common control with Licensee.

“Application” means the process described in Article 4 hereof used by the Licensee to receive Licensor’s permission to install initial facilities, to modify existing facilities, or to add additional facilities outside the Licensee’s allocated twelve inches (12”) of space on Licensor’s poles as provided herein. The form used for the Application process is identified as Exhibit 1 and is included as a part of this Agreement.

“Attachment” means any Wireless Facility or related equipment attached to a Pole, including, but not limited to, brackets, cables, Service Drops, power supplies, amplifiers, pedestals, bonding wires, Overlashings, guy wires and anchors required to support unbalanced loads. A single Attachment includes the vertical space consisting of a total of twelve inches (12”) either above or below, but not both, the bolted Attachment, exclusive of riser or conduit.

“Clearance Space” means the space on the Pole below the point where horizontal wire or horizontal cable equipment may not be installed in accordance with the Specifications. For purposes of this definition, “horizontal” means spanning from Pole to Pole or extending more than three feet (3’) from the surface of the Pole.

“Communications Space” means the space on the pole immediately below the Power Space extending to the lower of the existing lowest horizontal cable attachment, as specified by the National Electrical Safety Code, or reserved space, if applicable.

“Contact Person” is defined in Article 20.

“Cost in Place” means the cost of the bare pole, labor to install the pole and associated overheads, including engineering.

“Effective Date” is defined in the Preamble.

“Licensor” is defined in the Preamble.

“Force Majeure Event” is defined in Article 28.

“Inventory” means an Inventory of Licensee’s Attachments which will confirm the total number of Licensee’s Attachments, a summary of obvious non-conforming Attachments and any pending Licensee Transfers to Licensor poles.

“Interference” for the purposes of this Agreement, may include, but is not limited to, any use on the property or surrounding property that causes electronic or physical obstruction with, or degradation of, the communications signals from the communication facility.

“Joint User” means a person or entity that is currently occupying or reserving space on Licensor’s Poles, and has a right to attach to a Pole or anchor owned, controlled, or otherwise operated by Licensor in return for granting Licensor equivalent rights of Attachment or occupancy to poles and/or anchors, which the Joint User owns.

“Licensed Pole” means a pole for which Licensee has a valid and effective permit to locate and maintain an Attachment to the terms of this Agreement.

“Licensee” means the party having the right under this Agreement to make and maintain Attachments on a Licensor Licensed Pole as defined in the Preamble.

“Licensee Transfer Date” is defined in Article 7.

“Licensor” means the utility defined in the Preamble.

“Make Ready” means all work necessary or appropriate to make space for or otherwise accommodate new, additional or changed Attachments, including, but not limited to, necessary or appropriate Rearrangements, removal and replacement of the pole, Transfers and other work incident thereto.

“Make Ready Costs” means all costs necessary for Licensor, and other existing parties on the applicable Pole, to prepare the Poles for Licensee’s new, additional or modified Attachments, including, but not limited to, the costs of materials, labor, engineering, supervision, overheads, and tree trimming costs. Engineering includes design, proper conductor spacing and bonding, calculations to determine proper ground clearances and pole down guy and anchor strength requirements for horizontal and transverse loading, and compliance with all applicable requirements. Also included among Make Ready Costs are the costs of installing or changing out primary Poles, secondary Poles and drop and lift poles, including the cost of installation and/or removal of guys, anchors, stub poles, materials and equipment, temporary construction and all other construction in accordance with the technical requirements and specifications as outlined in this Agreement. Licensor Make Ready Costs shall be verifiably comparable to the cost Licensor pays for similar Make Ready Work to its own facilities.

“Make Ready Estimate” means the estimate prepared by Licensor for all Make Ready Work that may be required by Licensor to accommodate Attachment(s) by Licensee.

“Make Ready Work” means all work required by Licensor or others attached to the Pole to accommodate Attachment(s) by Licensee.

“NESC” is defined in Article 3.

“Outside Party” or “Third Party” is defined as persons or entities not party to this Agreement.

“Parties” is defined in the Preamble.

“Pole” or “pole” means a wooden, concrete or steel structure owned, controlled, or otherwise operated by Licensor to support distribution lines and related facilities of Licensor, including drop, lift, light poles and streetlight poles that do not support distribution lines and related facilities.

“Power Space” means any space on the pole primarily utilized by Licensor for the distribution of electric power, space between power lines, and includes the space from the top of the pole down to the Communications Space and includes the space above the Communications Space designated by the National Electrical Safety Code as the “communication worker safety zone”.

“Rental Fee,” “rental fee,” “Rental” or “rental” means the annual amount per billable Attachment (as defined herein) that Licensee must pay to Licensor pursuant to Article 13 of this Agreement.

“Rearrangement” means the moving of Licensee Attachments, the Licensor’s equipment or a third party’s equipment from one position to another on the same Pole.

“Referee” is defined in Article 21.

“Safety Inspection” means an inspection of Licensor poles to identify and remediate non-conforming Attachments (e.g. NESC violations) and other safety conditions on Licensor poles, performed after the Effective Date.

“Service Drop” means a Licensee wire or other facility used to connect to a customer’s location from a Licensor pole.

“Specifications” is defined in Article 3 hereof.

“Transfer” means the removal of Attachments from one Pole and the placement of such Attachments upon another Pole.

“Unauthorized Attachment” means any affixation of any Licensee Attachment to Licensor Poles, which has not been authorized as required by this Agreement.

“Unauthorized Attachment Fee” means the fee to be paid by Licensee for each Unauthorized Attachment.

“Wireless Facilities” means equipment at a fixed location that enables wireless communications between user equipment or nodes of a communication network, or both, including:

(A) Equipment associated with wireless communications; and

(B) Radio transceivers, surface wave couplers, antennas, coaxial or fiber optic cables, regular and backup power supplies and comparable equipment regardless of technological configuration.

The term shall not include the structure or improvements on, under or within which the equipment is collocated nor shall it include wireline backhaul facilities or coaxial or fiber optic cable that is between wireless structures or utility poles or that is otherwise not immediately adjacent to or directly associated with a particular antenna.

B. The following rules of interpretation apply to this Agreement and are by this reference incorporated into this Agreement:

(1) the word “or” is not exclusive and the words “including” or “include” are not limiting;

(2) the words “hereby,” “herein,” “hereof,” “hereunder” or other words of similar meaning refer to the entire document in which it is contained;

- (3) a reference to any agreement or other contract includes permitted supplements, amendments and restatements;
- (4) a reference to a law includes any amendment or modification to such law and any rules or regulations promulgated thereunder or any law enacted in substitution or replacement therefore;
- (5) a reference to singular includes plural and vice-versa and each gender includes the other;
- (6) a reference to days, months, or years refers to calendar days, months, and years, unless business days are specified;
- (7) Article and Section headings and table of contents are only for reference and are not to be considered in interpreting this Agreement;
- (8) a reference to an Article, Section, Appendix, Exhibit or Schedule which does not specify a particular document is to the relevant Article, Section, Appendix, Exhibit or Schedule of the document containing the reference;
- (9) a reference to an Article includes all Sections and subsections contained in such Article, and a reference to a Section or subsection includes all subsections of such Section or subsection;
- (10) All terms not otherwise defined herein will have the meaning commonly ascribed thereto in the relevant industry;
- (11) "\$" or "dollars" refers to United States dollars; and
- (12) The word "will" has the same meaning as "shall."

### **ARTICLE 3 – SPECIFICATIONS**

A. The use of the Poles covered by this Agreement shall be in conformity with all applicable provision of the following (the "Specifications"): (1) Section 5 "Joint Use and Clearances" of the Electric Cities of Georgia Inc. Construction Assembly Specifications (a copy of which is attached hereto as Exhibit 6 and incorporated herein by this reference) as it applies to Licensee's Attachments, and subsequent revisions thereof, provided Licensor provides Licensee sixty (60) days written notice of such revisions; and (2) requirements of the National Electrical Safety Code (2012) of The Institute of Electrical and Electronics Engineers, Incorporated and subsequent revisions thereof ("NESC"). Where there is a disagreement between Specifications, the applicable NESC Specifications shall apply. Modifications of, additions to, or construction practices supplementing wholly or in part the requirements of the Specifications shall, when accepted in writing by both Parties hereto, likewise govern the Licensee's use of Poles, and when so accepted shall be included within the term "Specifications." Any revision to the Specifications shall apply on a prospective basis, except as otherwise required by the NESC or any applicable law. No Application is necessary to correct safety violations or comply with applicable Specifications.

B. Each Party shall keep its Attachments in safe condition and in thorough repair. Licensee's Attachments shall be identified consistent with the Georgia Overhead Marking

Standards as adopted by the Georgia Utilities Coordinating Council. Attachments previously in place on Licensor's Poles shall be so identified by Licensee as regular or emergency work occurs or at the next system rebuild opportunity, but not later than five (5) years from the Effective Date of this Agreement. Licensee shall be responsible for periodically inspecting its Attachments to ensure they have permanent identification markers. After the fifth year, should Licensor encounter any of Licensee's Attachments without permanent identification markers, Licensor may notify Licensee, provided that Licensor can identify the Attachments as belonging to Licensee. If the markers are not placed within sixty (60) days of such notice, then Licensor may install the necessary markers, and Licensee shall reimburse Licensor for the cost of such work.

#### **ARTICLE 4 – ESTABLISHING ATTACHMENTS TO POLES**

Before Licensee shall make use of Licensor's Poles under this Agreement, or modify existing attachments, it shall submit an Application, as required herein. The Application shall be sent either (i) by electronic mail with electronic mail "read" receipt obtained, (ii) hand delivery or (iii) by being deposited in the United States mail with proper postage and properly addressed to the person receiving the Application. When transmittal is by hand or U.S. mail, the Licensee will also send an electronic mail message, return receipt requested, to Licensor as notice that the Application was hand-delivered or sent by the U.S. mail.

##### **A. APPLICATION AND NOTIFICATION PROCEDURE**

1. Except in connection with (i) Pole Transfers, (ii) correcting noncompliance, (iii) removals (iv) modifications subject to subsection (2) below; or (v) any other written Licensor requested action of the Licensee, Licensee must submit to Licensor an Application for any Licensee construction on Licensor Poles (including reconstruction of existing Pole lines) that involves the placement of new or additional Attachments.
2. Subsequent to the original installation of Licensee's Attachments, Licensee may make modifications to or replace Licensee's Attachments, or may alter, enhance, and upgrade its Attachments, so long as such modification, replacement, substitution, alteration, enhancement, or upgrade does not increase pole loading beyond the pole loading that was established in the approved Application or involve placement of Attachment outside the area designated in the approved Application, without obtaining prior written consent of Licensor. Any modification that would involve increasing the pole loading or outside the area designated beyond what was established in the approved Application shall require Licensee to submit a new Application for such pole.
3. Licensee shall submit a completed Application on the form attached hereto and identified as Appendix A, and all supporting data in accordance with said Application, or such other form as may be mutually agreed upon, specifying fully, to the extent applicable, the information shown on Appendix A.

Application Fee – Licensee shall be charged in the amount of fifty dollars (\$50) for each Pole submitted under this Agreement. Licensor shall keep a cumulative annual total of Application Fees and invoice Licensee for such Application Fees annually, along with the annual Rental Fees. The invoice provided for herein shall be paid by the Licensee simultaneously with its payment of the annual Rental Fees. Failure to include



all pertinent information relating to the Application set forth in Appendix A will result, at the Licensor's option, in the returning of the Application to Licensee unapproved or holding the Application until the required documentation is received. Licensor will make timely and reasonable efforts to contact Licensee should its Application be incomplete.

Inspection Fee – Except for any work required by Licensor, including, but not limited to, Transfers and rearrangements done at the request of Licensor or a third party, road improvement projects, and the installation of new Poles where none currently exist, Licensee shall pay Licensor for the reasonable Actual Costs incurred by Licensor in (i) performing field inspections, only as may be necessary to ensure compliance with this Agreement, which fees shall be reasonable and based upon actual costs incurred, and (ii) preparation of an estimate of the Make Ready Costs of each Pole covered in the Appendix A, which costs may set as fixed fees from time to time with the mutual agreement of the parties. The Licensor will provide, as a deliverable for the above inspection fees, a Pole inspection report with appropriate data as the Parties may agree upon. Licensee shall reimburse Licensor for such costs within sixty (60) days of receipt of the invoice from Licensor.

Timeframes:

- (a) Licensor shall approve, approve with conditions, or deny Licensee's Application within sixty (60) days after the receipt of a completed Application, provided that, all attachments at all locations of the Application are substantially similar; provided that if any Make-Ready Work is necessary, Licensor shall provide a Make-Ready Estimate, as provided, below.

If Licensee's Application is approved or if Licensee's Application is not rejected within the applicable period specified above, the Application will be considered approved and the Licensee shall have the right to place Attachments on such Pole(s) as provided in this Agreement. If Licensee's Application is conditionally approved, Licensor shall include a Make Ready Estimate within forty-five (45) days of Licensee's Application and approval of such Application shall be conditionally approved based upon payment of the Make Ready Estimate with its response. If the Licensor rejects the Application in whole or in part, the Licensor will specify the reason(s). The Application shall be rejected only for good cause, as provided for in Article 1.

4. The Make Ready Estimate shall offer sufficient detail so that Licensee can readily identify the components of the proposed Make Ready Work and shall reflect costs that are verifiably comparable with Licensor Actual Costs. If necessary, the Licensee shall request clarification on the Make Ready Cost before requesting the Licensor to commence Make Ready Work. The Licensor's total charges shall be consistent with Article 8 herein (will not exceed 120% of the estimate), unless such additional costs are caused by changes in Licensee's plans from the original permit. Licensee will provide written acceptance of the Make Ready Estimate within fourteen (14 days) of receipt. If written response, is not provided within fourteen (14) days, the Application will be considered denied.

5. Licensor shall complete Make Ready Work on Applications within sixty (60)

calendar days of receipt of Licensee's written acceptance of the Make Ready Estimate for such Make Ready Work. Licensee may request expedited handling of Licensor's work, and Licensee shall be responsible for the additional Actual Costs incurred by Licensor for such expedited processing. Licensee is responsible for coordination of all other Licensees or Joint Users to similarly expedite the completion of all Make Ready Work. Licensee shall make payment for Licensor's Make Ready Work within sixty (60) days of the written acceptance.

6. Any work undertaken on or in furtherance of Licensee's use of the equipment Above the Communications Space of any pole, shall be performed by Licensor's employees, Licensor's contractors, or approved contractors (Exhibit 5). Unless otherwise specifically approved in advance by Licensor, neither the Licensee, nor its contractors shall be allowed to perform the Make-Ready Work related to Licensee's equipment Above the Communications Space.

7. Licensor shall provide written notice to Licensee no later than seven (7) business days following the completion of Make Ready Work. Upon receipt of notice by Licensee from Licensor that the Make Ready work has been completed, the Licensee shall have the right hereunder to place its Attachments in accordance with the terms of the Application and this Agreement (including Article 3 herein). If the Licensee fails to initiate construction within one hundred eighty (180) days from the Licensor's notice of completion of Make Ready Work, the Licensor may, in its sole discretion, deem the Application approval terms and conditions outlined in the Appendix A null and void, and require the submission of another Application, along with engineering fees necessary to reimburse the Licensor for revised engineering and cost estimates, in the event Licensee still desires to attach to the Poles originally approved for attachment. Where field conditions preclude such compliance (e.g., when the Licensee's construction is delayed), Licensee shall notify the Licensor prior to the one hundred eightieth (180<sup>th</sup>) day. Licensee shall provide written notice to Licensor no later than twenty (20) business days following the completion of Licensee's work so that Licensor may perform its inspection of Licensee's new or modified Attachments to Licensor's Pole.

(a) Licensee and Licensor shall each place, Transfer and rearrange its own Attachments and shall place guys and anchors to sustain any unbalanced loads caused by its Attachments. Anchors and guys shall be in place and in effect prior to the installation of Attachments and cables. Each Party shall, with due diligence, attempt at all times to execute such work promptly and in such manner as not to interfere with the service of the other Party.

(b) The cost of making Attachments on existing Poles as provided herein, including the making of any necessary Pole replacements, shall be borne by the Parties hereto in the manner provided in Article 8.

8. Any work undertaken on or in furtherance of Licensee's use of the equipment Above the Communications Space of any pole, shall be performed by Licensor's employees, Licensor's contractors, or approved contractors (Exhibit D). Unless otherwise specifically approved in advance by Licensor, neither the Licensee, nor its contractors shall be allowed to perform the Make-Ready Work related to Licensee's

equipment Above the Communications Space. For Licensor's failure to meet the required timelines for Make-Ready Work Above the Communications Space, as set forth in this section, as applicable, Licensee, after attempting to resolve the dispute, may file a complaint for unreasonable delay on the part of Licensor with the FCC or with the state public utilities commission exercising jurisdiction or other authority; and further, a rebuttable presumption applies in such proceedings that access to Licensor's poles or facilities has not been provided on just and reasonable terms and conditions.

9. Post Inspection. Licensor may perform a post-construction inspection to measure and/or to visually observe Licensee's facilities, within thirty (30) days of completion of construction to ensure the attachment and installation of the Licensee's facilities conform to the requirements of this Agreement. Licensee shall bear the reasonable and actual costs incurred of such inspection provided the inspection is completed within thirty (30) days after written notification by Licensee of non-compliance. If the Licensee's facilities are not in compliance, the Licensee shall bring its facilities into compliance within thirty (30) days after notification of non-compliance and notify Licensor in writing upon completion. Licensee shall bear the reasonable and actual costs of all subsequent inspections necessary to verify the facilities have been brought into compliance. If not brought into compliance within ninety (90) days from initial notification from Licensor, Licensor may have an approved contractor perform the work and Licensee will be responsible for cost.

10. Electricity. Licensee shall secure and pay all charges for any electricity service furnished to each Attachment. Licensee may install or cause to be installed a separate electric meter base as required by the Licensor for the operation of Licensee's facilities.

## **ARTICLE 5 – RADIO FREQUENCY**

A. Radio Frequency Emissions. Licensee is solely responsible for the radio frequency ("RF") emissions emitted by its equipment. Licensee is jointly responsible for ensuring RF exposure from its emissions, in combination with the emissions of all other contributing sources of RF emissions, is within the limits permitted under all applicable rules of the Federal Communications Commission ("FCC"). To the extent required by FCC rules, Licensee shall install appropriate signage to notify workers and third parties of the potential for exposure to RF emissions. Licensee will communicate and cooperate with other pole attachers which emit RF to minimize the number of signs.

B. Each Party and Other's Responsible for Own Equipment. The Licensor and Licensee are under a duty and obligation in connection with the operation of its own, facilities, now existing or in the future, to protect against RF interference to the RF signals of Licensor and such other existing attachers at the time of the Application, as may be applicable. Each party to this Agreement shall endeavor to correct any interference to other networks created by its RF emissions promptly and shall coordinate and cooperate with each other relating to the same.

C. RF Power Cut-off Switch. Licensee shall install a power cut-off switch on every Licensor pole or facilities to which it has attached facilities that can emit RF energy. In ordinary circumstances, Licensor's authorized field personnel will contact the Licensee's designated point of contact provided pursuant to Section 22 to inform the Licensee of the need

for a temporary power shut-down. Upon receipt of the call, Licensee will power down its antenna remotely, the power-down will occur during normal business hours and with 24 hours advance notice. In the event of an unplanned power outage or other unplanned cut-off of power, or an emergency, the power-down will be with such advance notice as may be practicable and, if circumstances warrant, employees and contractors of Licensor may accomplish the power-down by operation of the power disconnect switch without advance notice to Licensee and shall notify the Licensee as soon as possible. In all such instances, once the work has been completed and the worker(s) have departed the exposure area, the party who accomplished the power-down shall restore power and inform the NOC as soon as possible that power has been restored.

D. **Emergency After Hours Contact Information.** Licensee shall provide emergency after hours contact information to Licensor including 24/7 telephone and/or pager information, a list of duty managers by district and escalation procedures. Licensee shall be required to include signage which indicates Licensor emergency contact information, Licensee's emergency contact information, and National Electrical Safety Code ("NESC") required information.

E. **Installation and Upkeep of Sign(s).** Licensee is responsible for the installation and upkeep of its sign or signs on each pole. The signage will be placed so that it is clearly visible to workers who climb the pole or ascend by mechanical means. The signs will contain the information approved for such signs by the FCC, or in the absence of FCC approval, the information commonly used in the industry for such signs.

## **ARTICLE 6 – RIGHT OF WAY FOR LICENSEE'S ATTACHMENTS**

Licensor's approval of an Application shall include a non-exclusive license access and use Licensor's rights-of-way for the purposes described in this Agreement to the extent Licensor acts in its capacity as an electric service provider and the approved Application, which license shall be subject to Licensee's continuing obligation to obtain such additional permits and approvals as may be required by the Licensor in other capacities (e.g., as a local government or regulatory body) or relevant third parties for work performed within the rights-of-way relating to the installation, maintenance, repair, replacement or modifications of approved Attachments. Licensor does not warrant or assure to the Licensee any right-of-way privileges or easements on, over or across streets, alleys and public thoroughfares, and private or publicly owned property, and if the Licensee shall at any time be prevented from placing or maintaining its Attachments on the Licensor's Poles, no liability on account thereof shall attach to the owner of the Poles; and Licensee shall be further responsible for obtaining all rights, permissions and approvals from other parties as may be necessary to exercise the rights, benefits and privileges contemplated herein.

Licensor shall maintain pole line right-of-way clearances according to Licensor's standard procedures, except with respect to Make Ready. Licensee is responsible for providing right-of-way clearances outside of Licensor's standard clearance practices at its own expense.

## **ARTICLE 7 – MAINTENANCE OF POLES AND ATTACHMENTS**

A. The Licensor shall maintain all Poles in a safe and serviceable condition and in accordance with the Specifications, and shall replace, reinforce or repair Poles as they become

defective. Licensee acknowledges that Poles and related items carry hazardous voltages, deteriorate over time and may contain various hazardous chemicals or properties. Licensee shall instruct and equip its personnel, including its employees, contractors and other agents, of the hazards associated with working on Licensor's Poles, and Licensee will provide necessary training and equipment for its representatives to safely execute their work on Licensor's Poles. Prior to working on a Pole, Licensee shall, through visual inspection and reasonable effort, make an assessment that the pole is in safe working condition. If Licensee believes that a pole contains non-compliant or unsafe conditions, Licensee shall promptly notify Licensor of any existing substandard condition (i.e., physical, mechanical or electrical, etc.), that jeopardizes either the general public or workman safety, and Licensor will cause the existing condition to be promptly corrected. Licensee will insure that contractors will comply with provisions of this Agreement. Licensor does not warrant, guarantee, or imply that any Pole abandoned by Licensor possesses sufficient mechanical strength as required by or for any use of Licensee.

B. When replacing a Pole carrying terminals of aerial cable, underground connection, or transformer equipment, the new Pole shall be set in the same hole which the replaced Pole occupied, or immediately adjacent, and in a manner to facilitate Transfer of Attachments, unless special conditions make it desirable to set it in a different location. Replacement Poles where risers (dips) are installed should be set as close as possible to the existing Pole. The Licensor will make reasonable effort to conduct a joint field review or otherwise coordinate with Licensee to determine the location of the proposed Pole. Reasonable effort will be made to coordinate locations of risers and Service Drops with the locations of the power facilities serving the customer.

C. Except during restoration efforts after natural disasters, such as a Force Majeure events, whenever it is necessary to replace or relocate a Licensed Pole, the Licensor shall, before making such replacement or relocation, give notice via the electronic notification system of pole transfer request, provided by the National Joint Utilities Notification System ("NJUNS"), of not less than sixty (60) days for five (5) poles or less and ninety (90) days for six (6) poles or more (except in case of emergency, when verbal notice will be given and subsequently confirmed in writing) to the Licensee, specifying in such notice the time of such proposed replacement or relocation, and the Licensee shall at the time so specified Transfer its Attachments to the new or relocated Pole. On highway relocation projects, the schedule for Transfers shall be consistent with the "utility adjustment schedule" and any subsequent revisions or with any other schedule issued by the appropriate authority governing a highway relocation project.

NJUNS code Licensor CTYOXF

NJUNS code Licensee VZFGA

D. Should the Licensee fail to Transfer its Attachments to the newly Licensed Pole after the date specified for such Transfer of Attachments and after all third party and Licensor responsible Transfers have been accomplished to the extent necessary for Licensee to affect its facilities Transfer, whichever is later ("Licensee Transfer Date"), the parties will have the following rights, in addition to any other rights and remedies available under this Agreement: The Licensor may hire a contractor approved by Licensee to transfer the facilities at Licensee's cost. Licensee will furnish a list of contractors authorized to perform such transfers. Alternatively, Licensor may sell such Pole to Licensee "as is" and the Licensee will

indemnify, defend and save harmless the Licensor from all obligation, liability, damages, cost, expenses or charges incurred thereafter, and not arising out of anything occurring prior to the transfer of ownership. Licensor will further evidence transfer of title to the Pole by appropriate means.

E. Licensee shall have twenty-four hour (24/7) access to its equipment in Communications Space for maintenance and repair.

F. Each party shall at all times maintain all of its Attachments in accordance with the Specifications in Article 3.

#### **ARTICLE 8 – DIVISION OF COSTS**

A. **NEW POLES INSTALLED WHERE NONE CURRENTLY EXIST.** Whenever Licensor requires new Pole facilities within the Licensee's service territory for any reason, including an additional Pole line, an extension of an existing Pole line, or in connection with the reconstruction of an existing Pole line, it shall make a best effort to notify Licensee to that effect in writing (verbal notice subsequently confirmed in writing may be given in cases of emergency) stating the proposed location of the new Pole. In the case of emergency, the Licensee will preliminarily respond verbally on an expedited basis that it does or does not want to attach its Attachments and will generally describe its planned Attachments. Within a reasonable period (not to exceed fifteen (15) business days) after the receipt of such written notice, the Licensee shall submit an Application. To the extent that Licensee's planned Attachments require a pole taller or stronger than what Licensor would have installed absent Licensee's planned Attachments, the difference between the Cost in Place of such Pole and the Cost in Place of the existing Pole will be paid by the Licensee, the rest of the cost of erecting such Pole to be borne by the Licensor. If in connection with the construction of a Pole(s) the Licensee makes the payment required by this paragraph, then the Licensee shall in the future be entitled to attach on such Licensor's Pole(s) even if the Pole(s) does not at that time become a Licensed Pole.

B. **ADDITIONAL MID-SPAN POLE.** A Pole, including all appurtenances or fixtures, erected between Poles to provide sufficient clearance and furnish adequate strength to support the circuits of both the Licensor and the Licensee, which would have been unnecessary except solely due to Licensee's use, shall be erected at the sole expense of the Licensee, or in the case of multiple Licensees on the Licensed Pole, the cost shall be equally divided among all Licensees or Joint Users requiring the mid-span Pole.

C. **PAYMENTS DO NOT AFFECT OWNERSHIP.** Any payments for Poles made by the Licensee under any provisions of this Article shall not entitle the Licensee to the ownership of any part of said Poles for which it has contributed in whole or in part.

D. **REPLACEMENT OF EXISTING POLES.** Where an existing Pole is replaced for maintenance purposes, Licensor shall erect a Pole adequate for the existing Attachments and Attachments for which Applications have been delivered, unless such Application is denied in accordance herewith, and the Licensor will pay all the costs of installing the replacement Pole. Licensee will pay to replace its existing Attachments. The replaced Pole shall be removed and retained by Licensor.

1. A Pole larger than the existing Pole, which is installed to replace an existing Pole, the extra height or strength of which is due wholly to the Licensor's requirements, such as providing service, normal maintenance, or keeping the Licensor's wires clear of trees, shall be erected at the sole expense of the Licensor. The Licensor shall bear the full expense of replacing or Transferring all the Licensor's Attachments, and the Licensee shall bear the full expense of replacing or Transferring all the Licensee's Attachments.

2. For a Pole larger than the existing Pole, which is installed to replace an existing Pole, the extra height or strength of which is due wholly to the Licensee's requirements, including Licensee's requirements as to keeping the Licensee's wires clear of trees, the Licensee shall pay to the Licensor the Make Ready Cost of the new Pole.

3. For a Pole larger than the existing Pole, which is installed to replace an existing Pole, the extra height or strength of which is due wholly to a Joint User's requirements such as providing service, correcting a safety violation or keeping the Joint User's wires clear of trees, the Joint User shall pay all of the Make Ready Cost of the new Pole, including any costs associated with replacing or Transferring Licensee's Attachments.

4. Except as to existing contracts with Joint User, in the case of a Pole larger than the existing Pole, which is installed to replace an existing Pole, the extra height or strength which is due to the requirements of all parties on the pole, such as when the parties share responsibility for correcting a safety violation, the difference between the Cost in Place of such Pole and the Cost in Place of the existing Pole shall be shared equally by the Licensee and the Licensor, and other third parties, if applicable, the rest of the cost of erecting such Pole to be borne by the Licensor. The Licensor and Licensee shall replace or Transfer all Attachments at their own expense.

E. **RESPONSIBILITY FOR OWN ATTACHMENTS.** Each party shall place, maintain, rearrange, Transfer and remove its own Attachments at its own expense except as otherwise expressly provided herein.

F. **PAYMENT BASIS.** Payments made under the provisions of this Article may be based on the estimated or Actual Cost as mutually agreed upon (including overhead) of making such changes but in no event, however, shall either Party be required to pay for such changes more than 120% of the Estimated Cost supplied by the other if such cost estimate shall have been requested and furnished before the changes were made.

G. **UTILITIES INSTALLING LARGER POLES FOR UTILITY'S FUTURE USE.** In the event the Licensor installs a Pole larger than is initially required for Licensor's and Licensee's use in anticipation of Licensor's future requirements or additions, the additional space provided by Licensor shall be reserved for Licensor's sole use. Licensee may request documentation to validate the need for future space.

## **ARTICLE 9 – INSPECTIONS**

A. **INSPECTION PERFORMANCE.** Within a reasonable time, not to exceed two (2) years after the Effective Date of this Agreement, the Parties shall jointly perform a safety inspection to identify any safety violations of all parties on the Poles ("Initial Safety

Inspection”), including Licensor and Joint Users, except that no such Initial Safety Inspection will occur if Licensee does not have any existing Attachments at the time of this Agreement. Following the Initial Safety Inspection, and not more than once every five (5) years thereafter, Licensor may perform periodic system-wide safety inspections of Licensor Poles, including Licensee Attachments, upon six (6) months’ advance written notice to Licensee. Such notice shall describe the scope of the inspection and provide Licensee with an opportunity to participate. Licensee and Licensor, and other attachers to Licensed Poles, shall share equally in the Initial Safety Inspection cost whether the Initial Inspection is performed by the Licensor or a third party contractor. In the event the Initial Safety Inspection or any subsequent safety inspection is performed by a third party contractor, the Licensee shall have the right to seek bids from third party contractors prior to the inspection and propose such bids to Licensor. Licensor will not be required to use any third party contractor proposed by the Licensee, provided that any third party contractor used by the Licensor to perform any inspection shall charge no more than the lowest qualified bid proposal (in Licensor’s reasonable discretion) provided by the Licensee. For inspections performed after the Initial Inspection, Licensee will pay a pro-rata share of the Licensor’s inspection costs and will incur its own costs to participate in such periodic safety inspections. The Licensee’s pro-rata share of Licensor’s cost will be equal to the percentage of the total violations caused by Licensee’s Attachments as identified during the inspection.

B. CORRECTIONS. In the event any Licensee facilities are in violation of the Specifications and such violation poses an imminent danger to persons or property and is discovered (“Imminent Danger Violation”), Licensee shall correct such violation immediately. Should Licensee fail to correct such Imminent Danger Violation after notice, the Licensor may correct the Imminent Danger Violation and bill Licensee for the Actual Costs incurred. Licensee shall not be subject to any safety violation penalties pursuant to the Initial Safety Inspection provided that Licensee corrects any safety violation that is not an Imminent Danger Violation (a “Non-Imminent Danger Violation”) discovered during the Initial Safety Inspection within eighteen (18) months of the documentation and reporting of the unsafe conditions. Following the Initial Safety Inspection, if any Attachment of the Licensee is found to be a Non-Imminent Danger Violation of Article 3 herein, and Licensee has caused the violation, Licensee shall have sixty (60) days to correct any such violation upon written notice from Licensor, or within a longer, mutually agreed-to time frame if correction of the violation is not possible within sixty (60) days, such extended time to be not more than an additional sixty (60) days. Notwithstanding the foregoing grace periods, in the event Licensor or an Outside Party prevents Licensee from correcting a Non-Imminent Danger Violation, the timeframe for correcting such violation shall be extended to account for the time during which Licensee was unable to correct the violation due to such Licensor or Outside Party’s action. Licensee will not be responsible for the costs associated with violations caused by others. In all circumstances, all of the Parties on the Pole will work together to maximize safety while minimizing the cost of correcting any such deficiencies, but the Licensee shall be responsible for the full cost of any necessary or appropriate corrective measures associated with violations caused by Licensee, including removal and replacement of the Pole and all Transfers or other work incident thereto. Licensee shall insure that its employees, agents, contractors or other Outside Parties, which Licensee causes to work on Licensor Poles, will be notified of pending, unresolved Poles requiring corrective actions prior to activities on such Poles, and Licensee shall not allow unqualified or improperly equipped personnel to work on such Poles.



1. If any Attachment of the Licensor is found to be in violation of Specifications and Licensor has caused the violation, then the parties will work together to minimize the cost of correcting any such deficiencies, but the Licensor shall be responsible for the full cost of any necessary or appropriate corrective measures, including removal and replacement of the Pole and all Transfers or other work incident thereto.

2. If one or more Outside Party's Attachment caused the violation, then such Outside Party shall pay the corrective costs incurred by all who have Attachments on the Pole, including for the Licensee, Licensor and any other attachers; and the Licensor will make reasonable effort to cause the Outside Party to make such payment.

3. If there exists a violation of Specifications and it cannot be determined which party on the Pole, including Joint User, caused such violation or there is a mixture of the parties causing the violation, then the parties will work together to minimize the cost of correcting any such deficiencies, and all parties and Outside Parties who may have caused such violation will share equally in such costs; provided, however, that if a Party can modify its Attachments so that they no longer may be a cause of the violation or deficiency, then such Party may elect to make such modification instead of otherwise sharing in such costs. Such a modification shall not relieve a Party from sharing in such costs if the Party making the modification could have been a cause of any deficiency that remains.

C. **FAILURE TO CORRECT.** In the event an Imminent Danger Violation is discovered, Licensee shall correct such violation immediately, and, in any case, in no more than twenty-four (24) hours, except as otherwise agreed to by the Parties. Should Licensee fail to correct such Imminent Danger Violation within twenty-four (24) hours after notice or such alternative time period, the Licensor may correct the violation and bill Licensee for the Actual Costs incurred.

## **ARTICLE 10 – UNAUTHORIZED ATTACHMENTS**

If any Attachment is identified for which the Application requirements (as set forth herein), or notification requirements as provided for in Article 4, have not been satisfied ("Unauthorized Attachment"), Licensor will notify Licensee in writing. The Licensee shall pay to the Licensor a one-time fee of one hundred fifty dollars (\$150.00) per Unauthorized Attachment. Licensee will also submit a completed application to Licensor within five (5) business days and be subject to the provisions in Article 4.

## **ARTICLE 11 – ATTACHMENT COUNTS**

A. Not more often than once every five (5) years and in conjunction with the established cyclical attachment count, unless otherwise mutually agreed by the parties, inventories of Attachments shall be made by representatives of the parties to determine the number of Licensee's Attachments to Licensor Poles ("Actual Inventory"). Licensor shall provide three (3) months' advance written notice prior to the Initial Inventory and any subsequent Actual Inventory describing the scope of the Inventories so that Licensee may plan and fully participate in and budget for such Inventories.

B. Unless prevented by the provisions of a third party agreement, Actual Inventories and Initial Inventories shall include all Outside Parties attached to Licensor's Poles. Where multiple Outside Parties are included in the inventory, all participating Outside Parties shall incur a prorated share of the cost of performing the Actual Inventory, based on the number of Attachments each attacher has on Licensor's Poles. For a year for which there is an Actual Inventory, the Rental Fees provided for herein shall be based on the Actual Inventory and the following adjustments shall be made:

1. The difference between the number of Licensee Attachments found by the Actual Inventory for the year in question and the number of Attachments for which Licensee was most recently invoiced for Pole Attachment Rental Fees shall be prorated evenly based on the assumption that such Licensee Attachments were added evenly over the period since the last Actual Inventory, or five years, whichever period is shorter. In addition, the Unauthorized Attachment fee shall apply if an Unauthorized Attachment is identified by the Parties through an Actual Inventory.

2. If the number of Licensed Attachments in the previous annual rental invoice is less than the number of Licensed Attachments found by the Actual Inventory, then Licensee shall be entitled to a pro-rata refund from the Licensor or a credit to the Licensee based on the assumption that such Licensee Attachments were removed evenly over the period since the last Actual Inventory, or five years, whichever period is shorter.

3. In the event that Licensee identifies any discrepancies with the results of any Actual Inventory, the Initial Inventory or any Unauthorized Attachments identified by Licensor, Licensee shall be entitled to dispute such discrepancies by providing written notice to Licensor within 30 days of receipt of Inventory results, describing the nature of the discrepancy; and in the case of such dispute, the Parties agree to cooperate in good faith to reconcile any identified discrepancies within 60 days and prior to Licensor issuing any assessments to Licensee for any Unauthorized Attachments identified by Licensor.

## **ARTICLE 12 – ABANDONMENT OF LICENSED POLES**

A. To the extent permitted by law, if the Licensor desires at any time to abandon any Licensed Pole, it shall, except in the event of required Transfers as provided in Article 7, give the Licensee notice in writing to that effect at least sixty (60) days prior to the date on which it intends to abandon such Pole. If, at the expiration of sixty (60) days, the Licensor and all other third party and Joint Users have no Attachments on pole but Licensee has not removed its Attachments, Licensor may sell such Pole to Licensee "as is" and the Licensee shall save harmless the Licensor from all obligation, liability, damages, cost, expenses or charges incurred thereafter, and not arising out of anything occurring prior to the transfer of ownership. Licensor shall further evidence transfer of title to the Pole by appropriate means.

B. The Licensee may at any time abandon a Licensed Pole by removing any and all Attachments it may have thereon and by giving written notice thereof and thereafter, shall have no further obligation to pay Rental Fees or other fees required under this Agreement for any such abandoned Attachment location.

## **ARTICLE 13 – POLE ATTACHMENT RENTAL FEES**

- A. For a year in which there is no Inventory, the number of Licensee's Attachments used in calculating the Rental Fees shall be based on the number of Licensee Attachments for which Licensee was charged in the previous year plus the number of Licensee Attachments approved through the Application process since the last billing minus the number of Licensee Attachments for which notice of removal was provided.
- B. The applicable computation of payments and calculations as above provided shall be made on or about December 15th of each year for the next year's Rental Fees, each Party acting in cooperation with the other.
- C. Pole Attachment Rental Fees due from Licensee to Licensor shall be as indicated in Exhibit 2. The undisputed Pole Attachment Rental Fee herein provided shall be paid by Licensee within sixty (60) days after Licensee's receipt of the invoice.
- D. **SPECIFIC RENTAL RATES.** See Schedule 2.
- E. Licensor hereby represents and warrants as of the date hereof and covenants and agrees from and after the date hereof that none of the rates, benefits, terms, conditions or fees offered to any other entity with respect to wireless installations is or will be more favorable to such entity than those imposed on Licensee under this Agreement. If Licensor agrees to a rate, benefit, term, condition or fee that is more favorable than those imposed on Licensee under this Agreement, then Licensee shall be entitled under this Agreement to such rate or fee on and after such rate or fee becomes effective.

## **ARTICLE 14 – DEFAULTS**

- A. In the event either Party deems an event of default has taken place and prior to engaging in the formal default provisions in this Agreement, the appropriate representatives of the Licensee and Licensor, as identified in Article 20, shall meet in person or on the telephone to attempt to resolve the matter in good faith within ten (10) business days of the initial request of either Party to meet.
- B. In the absence of resolution of the matter in accordance with Article 14.A, the aggrieved Party may provide a notice of default to the other Party in writing. Upon receipt of such notice of default, the defaulting Party shall either work diligently and cooperatively with the non-defaulting Party to correct such default or present sufficient evidence that a default does not exist or is not the fault of the defaulting Party. If such default shall continue for a period of sixty (60) days after such notices, either Party may, at its sole discretion and option, terminate this Agreement in its entirety if the default pertains to all Poles; or, if Licensor is the defaulting Party, Licensee may terminate any affected Appendix A sites and/or pursue any remedy now or hereafter available to Licensee under the applicable laws or judicial decisions; or, if Licensee is the defaulting Party, Licensor may deny future Attachments and/or remove the Attachments of Licensee to which the default pertains at Licensee's expense. Notwithstanding the foregoing, the cure periods may be extended upon mutual agreement of the Parties if a cure is not reasonably possible within the time frames specified above.

C. Without limiting the effect of the immediately preceding paragraph, if after reasonable notice, Licensee shall default in the performance of any work it is obligated to do under this Agreement, the Licensor may elect to do such work, and the Licensee shall reimburse the Licensor for the reasonable and actual cost thereof. Licensor shall notify the Licensee in advance of its intent to do the work and the approximate cost of doing such work. Failure on the part of the Licensee to make such a payment, as set forth in Article 19 herein, shall, at the election of the Licensor, constitute a default under Section B of this Article 14.

#### **ARTICLE 15 – RIGHTS OF OTHER PARTIES**

A. If Licensor, prior to the execution of this Agreement, received or conferred upon others, not parties of this Agreement (“Outside Parties”), by contract or otherwise, rights or privileges to attach to, and/or reserve space on any of its Poles covered by this Agreement, nothing herein contained shall be construed as affecting said rights or privileges with respect to existing Attachments of such Outside Parties, which Attachments shall continue in accordance with the present practice. All future Attachments of such Outside Parties shall be in accordance with the requirements of the following paragraph, except where such Outside Parties have, by agreements entered into prior to the execution of this Agreement, acquired enforceable rights or privileges to make Attachments which do not meet such space allocations. Licensor shall derive all of the revenue accruing from such Outside Parties. Any contractual rights or privileges of Outside Parties recognized in this paragraph shall include renewals of or extensions of the term (period) of such contracts.

B. In the event any Pole or Poles of Licensor to which Licensee has made its Attachments would, but for the Attachments of Licensee, be adequate to support additional facilities desired by Licensor, Licensor’s subsidiary or affiliate, or by a Joint User with whom Licensor has a prior agreement and which Joint User is either occupying space or has requested to attach or reserve space on such Pole(s) prior to the placement of Licensee’s Attachment on such Pole(s), then Licensor shall notify Licensee of any changes necessary to provide an adequate Pole or Poles and Licensor or Joint User will reimburse Licensee for the incremental costs thereof. Should Licensee submit a request to make a new Attachment on a Pole that a Joint User is not already attached to but on which the Joint User has reserved space, Licensor will provide notice of such space reservation to Licensee, provided that Licensor has such knowledge on or prior to the date of Licensee’s Attachment request.

C. If Licensor desires to confer upon Outside Parties, by contract or otherwise, rights or privileges to attach to any of its Poles covered by this Agreement, it shall have the right to do so, provided all Attachments of such Outside Parties are made in accordance with the following: (1) such Attachments shall be maintained in conformity with the requirements of Specifications, and (2) such Attachments shall not be located within the space allocation of Licensee and (3) such Attachments will not interfere with Licensee’s Attachments. Licensor shall derive all of the revenue accruing from such Outside Parties.

#### **ARTICLE 16 – ASSIGNMENT OF RIGHTS**

The rights conferred by this Agreement may be transferred by the Licensee to any successor in interest that has or is contemporaneously granted a franchise by the applicable franchise

authority upon thirty (30) days written notice to the Licensor. Except as otherwise provided in this Agreement, including the immediately prior sentence, Licensee shall not assign or otherwise dispose of this Agreement or any of its rights or interests hereunder, or in any of the Licensed Poles, or the Attachments or rights-of-way covered by this Agreement, to any firm, corporation or individual, without the written consent of the Licensor, which consent shall not be unreasonably withheld or delayed, except to the United States of America or any agency thereof; provided, however, that nothing herein contained shall prevent or limit the Licensee's right to change of stock ownership, membership unit or interest, partnership interest, or control of Licensee, provide capacity, bandwidth, or grant of use in Licensee's facilities, mortgage any or all of its property, rights, privileges, and franchises, or lease or transfer any of them to another corporation organized for the purpose of conducting a business of the same general character, or to enter into any merger or consolidation; and, in case of the foreclosure of such mortgage or in case of lease, transfer, merger, or consolidation, its rights and obligations hereunder shall pass to, and be acquired and assumed by, the purchaser at foreclosure, the transferee, lessee, assignee, merging or consolidating company, as the case may be; and provided further that it is subject to all of the terms and conditions of this Agreement.

#### **ARTICLE 17 – WAIVER OF TERMS OR CONDITIONS**

The failure of either Party to enforce or insist upon compliance with any of the terms or conditions of this Agreement shall not constitute a general waiver or relinquishment of any such terms or conditions, but the same shall be and remain at all times in full force and effect.

#### **ARTICLE 18 – PAYMENT OF TAXES**

Each Party shall pay all taxes and assessments lawfully levied on its own property upon said Licensed Poles, and the taxes and the assessments which are levied on said Licensed Poles shall be paid by the owner thereof, but any tax, fee, or charge levied on Licensor's Poles solely because of their use by the Licensee shall be paid by the Licensee, except for any such tax, fee, or charge levied by Licensor, excluding any tax, fee, or charge hereunder or any business use tax related to franchise or franchise agreement.

#### **ARTICLE 19 – BILLS AND PAYMENT FOR WORK**

A. Upon the completion of work performed hereunder by either Party, the expense of which is to be borne wholly or in part by the other Party, the Party performing the work shall present to the other Party within ninety (90) days after the completion of such work an itemized statement of the costs, and such other Party shall, within sixty (60) days after such statement is presented, pay to the Party doing the work such other Party's proportion of the cost of said work.

B. All amounts to be paid by either Party under this Agreement shall be due and payable within sixty (60) days after receipt of an itemized invoice. Except as provided in Article 19.C below, any payment not made within sixty (60) days from the due date shall bear interest at the rate of 1.5% per month until paid, or if 1.5% exceeds the maximum rate allowed by law, then at the maximum rate allowed by law. If a Party bills the interest provided for in this paragraph but then receives a payment showing that the payment was timely made, the billing Party will write off and cancel the interest. Upon agreement of the Parties, a Party may pay by electronic

funds transfer, upon request and delivery of applicable bank routing information to the requesting Party for such purpose.

C. A Party receiving a bill may, in good faith and for good cause, dispute the amount or adequacy of substantiation for the bill. In the event that a Party so disputes only a portion of a bill, then such Party shall promptly pay the undisputed amount. In the event of such dispute, the Parties shall meet, by telephone or in person, within ten (10) business days of a dispute being raised to discuss the disputed item and establish a procedure for addressing the disputed amount in accordance with this Agreement. Upon resolution of the dispute, if the amount and substantiation were correct and sufficient, interest will be paid on the unpaid balance from the date of the initial bill at the rate of 1.5% per month until paid, or if 1.5% exceeds the maximum rate allowed by law, then at the maximum rate allowed by law; but, if the amount was not correct or substantiation was not sufficient, no interest will be payable unless the amount determined to be correct is not paid within sixty (60) days of receipt of substantiation and determination of the correct amount in which case interest will be payable for the period beginning after the end of such sixty (60) day period.

D. Except as to the rental fees, the fees specified in this Agreement shall be subject to an annual adjustment equal to the change in the most recent twelve month's Handy-Whitman Index for the South Atlantic Region, Account 364, Poles, Towers and Fixtures.

#### ARTICLE 20 – NOTICES

A. Except as otherwise provided in this Agreement, all notices and writings shall be made to the people ("Contact Person(s)") identified below, who from time to time may be changed by written notice.

B. By written notice pursuant hereto, a Party may from time to time specify a person in lieu of the person designated in Section A above to receive notices or writings with respect to specified matter(s) and/or geographic area(s), in which case such notices or writings shall be sent to that person as to such matter(s) and area(s).

C. Response to any notice or Application shall be made to the sender rather than to the person designated in Section A or B above.

D. Unless otherwise provided in this Agreement, any notice shall be in writing, which may, when mutually agreeable, include preservable and traceable electronic means, such as email or facsimile.

E. A second copy of any notice given under Article 14 or Article 22 of Agreement shall be given to the following persons, who may from time to time be changed by written notice:

If to Licensor:  
City of Oxford  
Attn: City Manager  
110 West Clark Street  
Oxford, GA 30054  
770-786-7004

With a copy to:  
Electric Cities of Georgia  
Christine Carling  
1470 Riveredge Parkway NW  
Atlanta, GA 30328  
770-919-6308  
ccarling@ecoga.org

If to Licensee:

Verizon Wireless (VAW) LCC  
D/B/A Verizon Wireless  
180 Washington Valley Road  
Bedminster, New Jersey 07921  
ATTN: Network Real Estate

With a copy to:

Verizon Wireless (VAW) LCC  
D/B/A Verizon Wireless  
One Verizon Place  
Alpharetta, GA 30004  
ATTN: SE Market General Counsel

F. In the event of the need for a temporary power shut-down, Licensor's authorized field personnel will contact Licensee at 1-800-264-6620 or other telephone number provided by Licensee and follow the instructions prior to working within one (1) foot of Licensee's equipment which emits RF.

G. The Parties will develop and maintain a joint form designating the people to whom notices shall be given pursuant to the foregoing.

Except as otherwise noted, all notices, requests, demands and other communications hereunder shall be in writing and shall be delivered personally with a receipt evidencing delivery, sent by nationally recognized overnight courier, in each case addressed to the appropriate Party at the address for such Party shown above or at such other address as such Party shall have previously designated by written notice delivered to the Party giving such notice. Except as otherwise permitted, any notice given in accordance herewith shall be deemed to have been given and received when delivered to the addressee, which delivery may be evidenced by signed receipt of the addressee given to the courier or postal service.

## **ARTICLE 21 – RESOLUTION OF CERTAIN DISPUTES**

A. In the event of a dispute regarding any compliance or non-compliance with the provisions of Article 3 of this Agreement, including which Party is responsible for any non-compliance and what corrective action, if any, is necessary or appropriate to remedy any such non-compliance, then the Parties shall each arrange for a representative to make a joint field visit to the Pole location to investigate whether a violation exists and if so, any corrective action needed and the Party or Parties responsible. The Parties will make a diligent and good

faith effort to resolve such disputes at the local level by the Parties' respective local engineers and local managers.

B. If the Parties are unable to resolve any such dispute at the local level, then either Party may (and with the other Party's consent after providing a written request from the requesting Party to the other Party) submit the matter for resolution to a "Referee," as defined below, for binding resolution according to the dispute resolution process described hereafter. A matter will be submitted to the Referee by sending a letter (by mail, hand-delivery or facsimile) to the Referee, with a copy provided to the other Party's representative who was involved in the attempt to resolve the dispute and the other Party's representative designated pursuant to Article 21.A or Article 21.B before or concurrently with the transmission of the letter to the Referee. The letter will include a summary of the dispute and will designate the Party's Contact Person for the dispute. The other Party will promptly respond with a letter similarly sent and copied that provides such Party's summary of the dispute and designates such Party's Contact Person for the dispute.

C. If the Parties mutually agree to do so, instead of proceeding under Section B above, the Parties may submit any dispute to the Referee by jointly sending the Referee a letter that includes a summary of the dispute and designates each Party's Contact Person for the dispute.

D. The Referee will make such investigation as deemed appropriate in his or her discretion, which will include hearing from each Party's Contact Person. The Referee may, but is not required to, engage in such other procedures or hearing as the Referee deems appropriate. The Parties will cooperate with the Referee.

E. The Referee will promptly issue a binding decision (to the extent permitted by law) in writing to the Parties, from which there will be no appeal. The Party whose position is not upheld by the Referee (which determination may be made by the Referee if requested to do so) will be required to pay for the Referee's fees and expenses. If both Parties' positions are upheld in part, they will share the Referee's fees and expenses equally. The Parties agree to be bound to pay the Referee's fees and expenses as provided herein.

F. The Referee will be appointed as follows:

1. Each Party will appoint an outside engineer or other qualified person and these two (2) appointees will appoint a third outside engineer or other qualified person (the "Referee") to serve as the Referee.

2. In the event that the two (2) appointees are unable within fourteen (14) days to agree upon a third outside engineer or other qualified person who is willing and able to serve as the Referee, then the Referee will be appointed as follows: Three (3) names will be blindly drawn from the list of persons then comprising the NESC committee whose work is most closely related to the dispute (e.g., Clearances Committee or Strength and Loading Committee), or such other group as may be mutually agreed upon. Each Party will strike one such name and the remaining person will serve as the Referee. If the Parties strike the same name, then the Referee will be selected from the remaining two (2) names by coin toss. If the NESC committee member so selected is unwilling or unable to serve as Referee, then this procedure will be repeated (starting with the blind drawing of three different names as provided above) as necessary until a



Referee is selected who is willing and able to serve as Referee. If all committee member names of the NESC committee first selected are exhausted without a Referee being appointed who is willing and able to serve as Referee, then the Parties will repeat the above-described procedure with the next NESC committee whose work is most closely related to the dispute, and so on until a Referee is selected who is willing and able to serve as Referee.

G. Nothing herein shall preclude the Parties from entering into any other mutually agreeable dispute resolution procedure or from changing by mutual written agreement any aspect of the foregoing procedure. Without limiting the generality of the foregoing, the Parties may by mutual written agreement remove, replace or appoint a Referee at any time.

H. The Parties agree, that if any dispute arising under this Agreement cannot be resolved at lower levels, communications between the following will be permitted and engaged in, in good faith on an expedited basis: Between a responsible senior officer with settlement authority of Licensor and a responsible senior officer with settlement authority of Licensee; and, if not resolved by them, between such persons' superiors, if any. If either Licensor or Licensee reorganizes or changes titles, the equivalent person for such Party shall perform the above functions. Notwithstanding the foregoing, neither Party shall be precluded from seeking any other available legal remedy at any time.

## **ARTICLE 22 – TERM OF AGREEMENT**

A. This Agreement shall continue in full force and effect for ten (10) years from the Effective Date (Initial Term), and shall automatically renew thereafter for five year terms thereafter (Renewal Term) unless terminated in accordance herewith. Either Party may terminate the Agreement by giving to the other Party one (1) years' notice in writing of intention to terminate the Agreement one (1) year prior to the end of the Initial Term or any Renewal Term. Notwithstanding the foregoing, this Agreement shall continue in full force and effect for all existing Attachments during any negotiations of the Parties for a subsequent agreement.

B. Upon final termination of this Agreement in accordance with any of its terms, Licensee shall, within one-hundred fifty (150) days, remove all its Attachments from all Poles. If not so removed, Licensor shall provide written notice to Licensee of such non-compliance and Licensee shall have an additional thirty (30) days to remove such Attachments from all Poles. If Licensee still fails to remove its Attachments upon expiration of such thirty-day period, then Licensor shall have the right to remove and dispose of all of Licensee's Attachments without any liability or accounting therefore. Licensee shall reimburse Licensor for any and all costs incurred by Licensor in the removal of Licensee's Attachments as detailed above. In the event that Licensee has not reimbursed Licensor within sixty (60) days of invoicing following Licensor's removal of said Attachments, then Licensor may pursue one or more of the remedies contained in Article 14, including making demand on the Security Instrument described in Article 25.

C. Termination of this Agreement shall not relieve either Party from fulfilling any and all of its obligations that accrued while the Agreement was in effect.

D. During the term of this Agreement or upon termination of this Agreement, each Party shall have reasonable access to those portions of the other Party's books, construction standards, and records, as may be necessary to resolve a material issue or concern regarding the other Party's compliance with its obligations under this Agreement. Such access will be granted upon reasonable notice and only during regular business hours.

#### **ARTICLE 23 – EXISTING CONTRACTS**

All existing joint use or pole attachment license agreements between the Parties, and all amendments thereto are by mutual consent hereby abrogated and superseded by this Agreement except with respect to amounts owed, late payment penalties and interest and remedies available for collection of such amounts by either party under any such existing agreements.

Nothing in the foregoing shall preclude the Parties to this Agreement from entering such supplemental operating routines or working practices as they mutually agree in writing to be necessary or desirable to effectively administer the provisions of this Agreement.

#### **ARTICLE 24 – LICENSOR SYSTEM FINANCING OR SALE OF SYSTEM**

This Agreement and any amendment thereof shall be effective subject to the condition that, during any period in which the Licensor has outstanding debt or other financing obligations respecting its Poles or its electric distribution system, this Agreement shall be subject to the terms and conditions related to such financing. Licensor, without the consent of the Licensee, may enter into or issue debt or other financing obligations from time to time related to its Poles or its electric distribution system with terms and conditions, including covenants that affect Licensee's rights hereunder, that are reasonably required by the counterparties to such transactions or the purchasers of such debt or other financing obligations. Subject to Article 15, Licensor, without the consent of the Licensee, may at any time sell or otherwise transfer ownership of all or any part of its Pole or electric distribution system, and in conjunction therewith, may terminate this Agreement or assign it to the purchaser or transferee in whole or in part after providing Licensee sixty (60) days' notice prior to such sale or transfer.

#### **ARTICLE 25 – LIABILITY AND INDEMNIFICATION**

A. Except as set forth below, Licensee assumes sole responsibility for all injuries and damages caused, or claimed to have been caused, by Licensee, its employees, agents, representatives or contractors. Notwithstanding the foregoing, Licensee shall have no liability to the Licensor for injuries and damages (a) caused by, through or as a result of the negligence of the Licensor; (b) caused by, through or as a result of the wanton misconduct of the Licensor; or (c) caused by, through or as a result of the facilities or activities of any third party (or parties) attachers whose cables, wires, appliances, equipment or facilities are attached to the same Poles as Licensee's cables, wires, appliances, equipment or facilities.

B. Accordingly, without limiting the effect of the provision of the immediately preceding paragraph, and except as set forth below, Licensee expressly agrees to indemnify, defend and save harmless the Licensor, its governing body, officers, employees, agents, representatives and contractors from all claims, demands, actions, judgments, loss, costs and expenses (collectively, "Claims") caused or claimed to have been caused by, Licensee, its employees,

agents, representatives or contractors, including with respect to (a) damage to or loss of property (including but not limited to property of the Licensor or Licensee); (b) injuries or death to persons (including but not limited to injury to or death of any Licensee employees, contractors or agents, or members of the public); (c) any interference with the consumer devices (including, for example but without limitation, televisions, radios, computers and similar equipment) which may be occasioned by the installation or operation of Licensee's cables, wires, appliances, equipment or facilities, provided such devices are operating in accordance with law, including, if applicable, on the appropriate FCC-licensed frequencies; (d) any injuries sustained and/or occupational diseases contracted by any of the Licensee's employees, contractors or agents of such nature and arising under such circumstances as to create liability therefore by Licensee or the Licensor under any applicable Worker's Compensation law, including also all claims and causes of actions of any character which any such contractors, employees, the employers of such employees or contractors, and all persons or concerns claiming by, under or through them or either of them may have or claim to have against the Licensor resulting from or in any manner growing out of any such injuries sustained or occupational diseases contracted; it being understood, however, that Licensee shall have no liability to the Licensor for injuries and damages (a) caused by, through or as a result of the negligence of the Licensor; (b) caused by, through or as a result of the wanton misconduct of the Licensor; or (c) caused by, through or as a result of the facilities or activities of any third party (or parties) whose cables, wires, or facilities are attached to the same Poles as Licensee's cables, wires, or facilities. In any matter in which Licensee shall be required to indemnify the Licensor hereunder, Licensee shall control the defense of such matter in all respects, and the Licensor may participate, at its sole cost, in such defense. The Licensor shall not settle or compromise any matter in which Licensee is required to indemnify the Licensor without the prior consent of Licensee.

C. To the extent permitted by law, the Licensor agrees to assume liability and be responsible for the payment of any sum or sums of money to any persons whomsoever on account of any Claims arising or claimed to have arisen by, through or as a result of the Licensor's negligent acts or omissions or the Licensor's intentional or wanton misconduct. Licensor shall have no liability to the Licensee for injuries and damages (a) caused by, through or as a result of the negligence of the Licensee or its contractors or agents; or (b) caused through or as a result of the wanton misconduct of the Licensee or any of its contractors, agents, representatives or assignees. Nothing contained herein shall constitute a waiver of the defense of sovereign immunity in favor of the Licensor.

D. Insurance. In the event Licensee's franchise agreement requires Licensee to insure the franchise authority, the Insurance requirements set forth in Article 25.E herein shall not apply to Licensee.

E. In the event Licensee is not required to insure the franchise authority, pursuant to the franchise agreement, Licensee, and any contractors of Licensee, shall contract for and maintain in effect throughout the period during which Licensee maintains Attachments on any Poles insurance that meets or exceeds the amounts set forth in subsections (1) through (3) below. Failure to provide and maintain the required insurance coverage shall constitute a Default under this Agreement, in which event Licensor shall have the right to pursue any and all of remedies set forth in this Agreement.

1. Worker's Compensation insurance in compliance with the statutory requirements of the state(s) of operation and Employer's Liability, with minimum limits of \$1,000,000 each accident/disease/policy limit, covering all employees of Licensee who shall perform any work on Poles or property owned or controlled by Licensor, including easements and rights-of-way, whether or not such insurance is required by law. If any employee is not subject to the Worker's Compensation laws of the state wherein work is performed, Licensee shall extend said insurance to such employee as though said employee were subject to such laws.

2. Commercial general liability insurance covering all insurable operations under this Agreement, including erection, installation, maintenance, Rearrangement and removal of Licensee's Attachments, in an amount of \$2,000,000 per occurrence for bodily injury and for property damage .

3. Commercial Automobile liability insurance covering all owned, non-owned, or hired vehicles used in connection with this Agreement, in an amount of \$2,000,000 combined single limit for each accident or occurrence for bodily injury or property damage.

4. The policies required hereunder shall be in such form and issued by such carrier as shall be reasonably acceptable to Licensor.

(a) Licensor, its governing body, officers, employees, and agents shall be shown as additional insured on each policy only with respect to liability arising from Licensee's operation in conjunction with this Agreement; and

(b) To the extent permitted by applicable laws, Licensee agrees to release and will require its insurers (by policy endorsement) to waive their rights of subrogation against Licensor, its governing body, officers, employees, and agents for loss under the policies of insurance described herein; and

(c) Each policy shall state that Licensor will be given notice at least thirty (30) days before any such insurance shall lapse; and

(d) Licensee shall furnish Licensor certificates evidencing such insurance within thirty (30) days of the Effective Date of this Agreement and shall provide Licensor with copies of any renewal certificates promptly after they become available.

(e) Notwithstanding the above, if Licensee is authorized to operate as a self-insured entity under the laws of the State of Georgia, Licensee may provide self-insurance to meet the requirements of this Article 25.E, upon terms and conditions satisfactory to Licensor.

F. SECURITY INSTRUMENT. Licensee shall furnish and maintain throughout the term of this Agreement, and thereafter until all of the obligations of Licensee have been fully performed, a bond or other security instrument ("Security Instrument") satisfactory in form and content to Licensor in substitution therefore, to guarantee the payment of any sums which may become due to Licensor or an Licensor Agent for Pole Attachment Rental Fees, inspections, inventories, Make Ready Costs, Unauthorized Attachment Fees, for work performed for the

benefit of Licensee under this Agreement, including the removal of Attachments upon termination of this Agreement, for any expense that may be incurred by Licensor or an Licensor agent because of any Default of Licensee, or for any other expense that is to be borne by Licensee under this Agreement. The amount of said Security Instrument, which amount shall be maintained throughout the term of the Agreement and thereafter until all of the obligations of Licensee have been fully performed, shall be equal to ten thousand US dollars (\$10,000), or twenty-five dollars (\$25) per Attachment, whichever is larger. The amount of the Security Instrument may, in Licensor's discretion, be adjusted if Licensee purchases, acquires, or obtains a controlling interest in additional broadband or other facilities within Licensor's service territory not currently covered by this Agreement which results in a significant increase in the number of Attachments. Any such adjustment shall not exceed twenty-five dollars (\$25) per new Attachment. Failure to provide and maintain the aforementioned Security Instrument shall be deemed a Default under this Agreement, in which event Licensor shall have the right to pursue any and all remedies set forth in this Agreement and at law or equity. The furnishing of such Security Instrument shall not affect, limit, diminish or otherwise reduce any obligations of Licensee under this Agreement.

G. Following the completion of the Initial Safety Inspection, the correction of the identified violations, and if the Licensee is in material compliance with all other terms and conditions of the Agreement, the amount of the Security Instrument shall be adjusted annually to an amount not to exceed the last annual Pole rental invoice received by the Licensee.

#### **ARTICLE 26 - COMPLIANCE WITH LAWS; CHANGE OF LAW**

A. Applicable Law. Both Parties shall comply with all applicable laws and regulations.

B. Change of Law. In the event that any legislative, regulatory, judicial, or other action affects the rights or obligations of the Parties, or establishes rates, terms or conditions for the construction, operation, maintenance, repair or replacement of small cells on city infrastructure or in the right of way, that differ, in any material respect from the terms of this Agreement ("New Law"), then either Party may, upon thirty (30) days written Notice, require that the terms of this Agreement be renegotiated to conform to the New Law. Such conformed terms shall then apply on a going forward basis for all existing and new small cell installations, unless the New Law requires retroactive application, in which case such new terms shall apply retroactively, as required by the New Law. In the event that the Parties are unable to agree upon new terms within 90 days after Notice, then the rates contained in the New Law shall apply from the 90<sup>th</sup> day forward until the negotiations are completed, or a Party obtains a ruling regarding the appropriate conforming terms from a commission or court of competent jurisdiction.

#### **ARTICLE 27 – CONSTRUCTION**

This Agreement was drafted by all Parties hereto and is not to be construed against any party. Neither the negotiations of the language of this Agreement nor any prior drafts of this Agreement or the inclusion or exclusion of any language from prior drafts shall be admissible or probative as to the meaning of this Agreement.

## ARTICLE 28 – REMEDIES CUMULATIVE

Unless otherwise provided in this Agreement, all remedies set forth in this Agreement are cumulative and in addition to any other remedies that may be available herein or at law or in equity, if any.

## ARTICLE 29 – MISCELLANEOUS

A. Counterparts. This Agreement may be executed in multiple counterparts, and any one of such counterparts shall be considered an original hereof.

B. Entire Agreement; Prior Agreements; Integration. This Agreement and its Exhibits set forth the entire understanding and agreement of the parties as to the subject matter herein, which is the attachment of small cell wireless antenna and related equipment to poles. No other prior verbal or written agreements or understandings by and between the parties related to the subject matter contained herein shall be effective and are hereby abrogated by, superseded by, or integrated into this Agreement. In the event of a conflict of any term and condition or provision among this Agreement, its Exhibits, and the Attachment permits, the following shall control in order of precedence: This Agreement; Exhibits to this Agreement; any Ordinances currently in effect; and Attachment Permits.

C. Severability. In case any one or more of the provisions of this Agreement shall for any reason be held to be illegal or invalid by a court of competent jurisdiction, it is the intention of each of the Parties hereto that such illegality or invalidity shall not affect any other provision hereof, but this Agreement shall be construed and enforced as if such illegal or invalid provision had not been contained herein, and this Agreement shall be construed to adopt, but not to enlarge upon, all the applicable provisions of applicable law, and, if any provisions hereof conflict with any provision of applicable law, the latter as in effect and as interpreted by the applicable courts shall prevail in lieu of any provision hereof in conflict or not in harmony therewith.

D. Force Majeure. As used in this Agreement “Force Majeure Event” means any act or event whether foreseen or unforeseen, that meets all of the following tests:

1. The act or event prevents a party (the “Nonperforming Party”), in whole or in part, from performing its obligations under this Agreement or satisfying any conditions to the other party’s obligations under this Agreement.
2. The act or event is beyond the reasonable control of and not the fault of the Nonperforming Party.
3. The Nonperforming Party has been unable to avoid or overcome the act or event by the exercise of due diligence.

E. Despite the preceding definition of a Force Majeure Event, a Force Majeure Event excludes economic hardship, changes in market conditions or insufficiency of funds.

F. In the event of a Force Majeure Event affecting Licensor's Poles, the Parties' obligations hereunder are suspended for a period of time reasonably appropriate to the Force Majeure Event to the extent performance hereunder adversely affected.

G. Modifications; Amendments. No amendment or modification of this Agreement shall be binding unless executed in writing by the Parties hereto.

H. Governing Law. Except to the extent that federal law, regulations, and/or agency orders control any aspect of this Agreement, the validity of this Agreement, the construction and enforcement of its terms, and the interpretation of the rights and duties of the parties will be governed by the laws of the State in which the subject poles are located.

I. Hazardous Materials. Licensor agrees to comply with applicable state and federal environmental laws and regulations including those governing hazardous materials and waste, and warrants that it administers and enforces policies, practices and procedures sufficient to achieve such compliance with respect to its facilities.

IN WITNESS WHEREOF the Parties hereto have caused these presents to be executed in two counterparts, each of which shall be deemed an original, and their corporate seals to be affixed thereto by their respective officers thereunto duly authorized, as of the Effective Date.

LICENSOR  
City of Oxford

By:   
Name:  
Its:

Attest:

By:   
Its: City Clerk

[SEAL]

LICENSEE  
Verizon Wireless (VAW) LCC D/B/A Verizon  
Wireless

By: \_\_\_\_\_  
Name:  
Its:

Attest:

By: \_\_\_\_\_  
Its:

[SEAL]



### Exhibit 1 – Application to Attach

Licensee hereby requests permission pursuant to its Pole Attachment License Agreement to make new Attachment(s) to Pole as shown on the attached construction plans and drawings. The attached plans and drawings show the Pole Licensee desires to attach to, the number and character of Attachments existing and proposed, any Rearrangements requested with respect to existing Attachments, any relocations or replacements of existing Pole requested, the heights of all points of attachment, all mid-span clearances, any new Pole placement requested, pole loading analysis report, and completed Radio Frequency Emission Certificate. Should additional information be required by the Electric Provider for verification of compliance with the NESC or other applicable standards, the Licensee will provide such information. The table below provides detailed information regarding this request.

<b>LICENSEE NAME:</b>			
Project		Proposed Attachments	
Request #		New	Modified
Request		Power Space	in.
Name		Communications Space	in.
Phone		Common Space	in.
E-Mail			
Estimated Construction Dates			
Start		Finish	
Signature			
<b>Include Attachments above the top of the Pole and in the Communications Worker's Safety Zone</b>			

Please advise Licensee as to whether or not these Wireless Facilities Attachments will be permitted and if necessary provide an estimate for any additional costs that Licensee may be required to pay as Make Ready Work. If Make Ready Work is required, upon receipt of Electric Provider supplied Make Ready Estimate, the Licensee shall provide notice to Electric Provider of either approval of the cost estimate or that Licensee will not undertake to make these Attachments. Upon receipt by Electric Provider of Licensee's notice of estimate approval of Make Ready Costs, the Electric Provider will proceed with Make Ready Work.

<b>ELECTRIC PROVIDER</b>			
Response Date		Make Ready Construction Required?	Yes
Name			No
Phone		Make Ready Construction Estimate	\$
Email			
Signature		Permit #	
Request	Approved	Reason for Denial:	
	Denied		

Capitalized terms used in this request, but not defined, have the meaning set forth in the applicable Addendum to Pole Attachment License Agreement for Attachment of Wireless Facilities or Pole Attachment License Agreement.

## Exhibit 2 –Fee Schedule

### Wireless Facilities Attachments

The Adjustment Payments for Wireless Facilities shall be calculated on a “per foot” basis. For purposes of calculating such Adjustment Payments for Wireless Facilities, every twelve inches (12”) of vertical space, or any part thereof, of each Wireless Facility component which is attached to the Pole, exclusive of riser and/or conduit, regardless of placement location, shall constitute one (1) attachment. For example, if Licensee’s Wireless Facility takes up thirty inches (30”) of vertical space on the Pole, such Wireless Facility will be considered as three (3) attachments for purposes of determining the Adjustment Payment for such Wireless Facility.

Term	Rental Fee	Invoice Date
Jan. 1, 2019 – Dec. 31, 2019	\$16.50	Dec. 1, 2019
Jan. 1, 2020 – Dec. 31, 2020	\$16.50	Dec. 1, 2019

For years beginning 2021, the annual Rental Fee per Attachment shall be adjusted by applying the annual change for account 364 for the South Atlantic Region from the latest version of the Handy Whitman Index.

Inspection Fees: [placeholder]

**Exhibit 3 - Radio Frequency Emissions Certification**

The Effective Isotropic Radiated Power (“EIRP”) of the Wireless Facilities shall comply with Part 15 of the FCC Rules and levels of radio frequency exposure from the Wireless Facilities will comply with Sections 1.1307(b) and 1.1310 of the FCC’s Rules, as clarified by the FCC’s *OET Bulletin 65*, latest revisions.

Will the Wireless Facilities that are the subject of the accompanying Application to Attach, dated \_\_\_\_\_, as installed, comply fully with the radio frequency exposure limitations at all distances for General Population/Uncontrolled Environments as specified by the Federal Communications Commission at 47 C.F.R. §1.1310 (or its successor regulation), the FCC’s *OET Bulletin 65*, latest revision, and any applicable state radio frequency exposure standards?

\_\_\_ Yes

\_\_\_ No

Certification:

I certify that: (i) I am a qualified/certified RF Engineer with experience regarding radio frequency emissions; (ii) I have performed the analysis specified in 47 C.F.R. § 1.1310 of the FCC’s rules and *OET Bulletin 65* for each and every one of the Wireless Facilities Attachments covered in the Request for Permission to Attach Wireless Facilities, dated \_\_\_\_\_, and (iii) the answer given above is true.

\_\_\_\_\_  
Signature

\_\_\_\_\_  
Print Name

\_\_\_\_\_  
License Number

**Exhibit 4 – Approved Contractors**

**Exhibit 5 – ECG Specifications**

[ATTACH SECTION 5 “JOINT USE AND CLEARANCES” OF THE  
ELECTRIC CITIES OF GEORGIA INC. CONSTRUCTION ASSEMBLY SPECIFICATIONS]

---

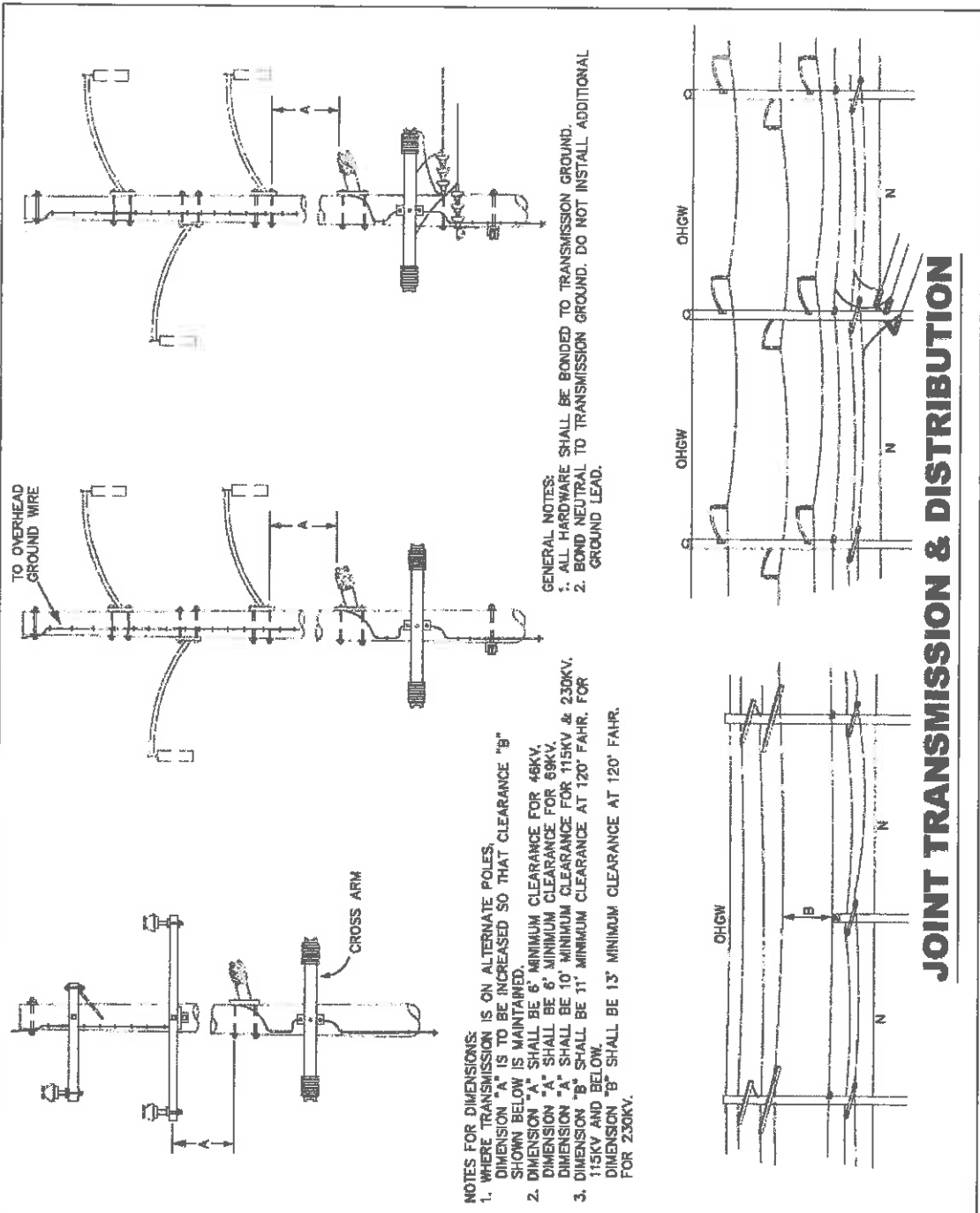

GENERAL NOTES:  
 1. ALL HARDWARE SHALL BE BONDED TO TRANSMISSION GROUND.  
 2. BOND NEUTRAL TO TRANSMISSION GROUND. DO NOT INSTALL ADDITIONAL GROUND LEAD.

NOTES FOR DIMENSIONS:  
 1. WHERE TRANSMISSION IS ON ALTERNATE POLES, DIMENSION "A" IS TO BE INCREASED SO THAT CLEARANCE "B" SHOWN BELOW IS MAINTAINED.  
 2. DIMENSION "A" SHALL BE 6' MINIMUM CLEARANCE FOR 48KV, DIMENSION "A" SHALL BE 6' MINIMUM CLEARANCE FOR 69KV, DIMENSION "A" SHALL BE 10' MINIMUM CLEARANCE FOR 115KV & 230KV, 115KV AND BELOW.  
 3. DIMENSION "B" SHALL BE 11' MINIMUM CLEARANCE AT 120' FAHR. FOR 230KV.  
 DIMENSION "B" SHALL BE 13' MINIMUM CLEARANCE AT 120' FAHR. FOR 230KV.

**JOINT TRANSMISSION & DISTRIBUTION**

 <p>DATE: <u>OCTOBER, 1992</u></p>	<p>REVISIONS <u>JULY, 2001</u></p> <p><u>JANUARY, 2007</u></p>	<p><b>JU&amp;C1</b></p>
---	--	-------------------------

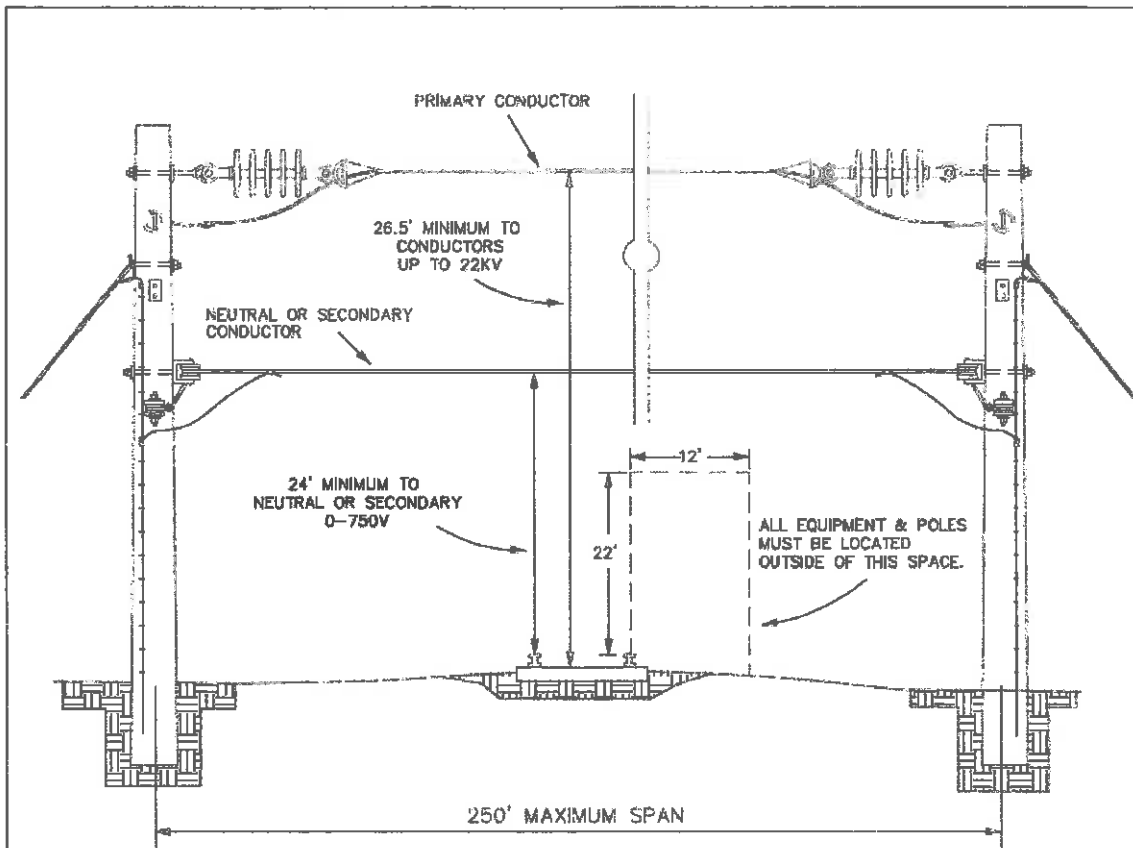

1. IF SPAN LENGTH EXCEEDS 250 FEET, CONDUCTOR CLEARANCE IS TO BE INCREASED 0.3 FEET FOR EACH 10 FEET SPAN LENGTH IN EXCESS OF THE 250 FEET.
2. CROSSINGS SHOULD BE MADE ON A COMMON SUPPORT STRUCTURE WHERE PRACTICAL. COOPERATION BETWEEN THE PARTIES CONCERNED SHALL PREVAIL PROPER CLEARANCES.
3. EXCEPTIONS TO 12' HORIZONTAL SIDE CLEARANCE:
  - (a) A CLEARANCE OF NOT LESS THAN 8 FEET MAY BE ALLOWED WHERE NECESSARY IF THE SUPPORTING STRUCTURE IS NOT THE CONTROLLING OBSTRUCTION, PROVIDED SUFFICIENT SPACE FOR A DRIVEWAY IS LEFT WHERE CARS ARE LOADED.
  - (b) WHERE NECESSARY TO PROVIDE SAFE OPERATING CONDITIONS WHICH REQUIRE AN UNINTERRUPTED VIEW OF SIGNALS, SIGNS, ETC. ALONG TRACKS THE PARTIES CONCERNED SHALL COOPERATE IN LOCATING STRUCTURES TO PROVIDE THE NECESSARY CLEARANCE.
  - (c) AT INDUSTRIAL SIDINGS, A CLEARANCE OF NOT LESS THAN 8 FEET SHALL BE PERMITTED, PROVIDED SUFFICIENT SPACE IS LEFT WHERE CARS CAN BE LOADED OR UNLOADED.

## **RAILROAD CROSSING CONSTRUCTION CLEARANCES**



DATE: OCTOBER, 1992

REVISIONS JULY, 2001  
JANUARY, 2007

**JU&C2**



**NOTES:**

1. THIS 40" CLEARANCE ALSO APPLIES TO THE CLOSEST METAL PORTION OF ANY ONE SPOOL OR FOUR SPOOL RACKS.
2. IF THE BOTTOM OF THE CONDUCTOR BRACKET IS LESS THAN 10" FROM THE BOTTOM OF THE TRANSFORMER TANK, THEN THE 40" REQUIRED SPACE FROM THE BOTTOM OF THE CONDUCTOR SHALL SUPERCEDE THE 30" SPACE FROM THE BOTTOM OF THE TRANSFORMER TANK.
3. MESSENGER STRAND SHALL BE BONDED TO THE POLE GROUND, IF PRESENT.

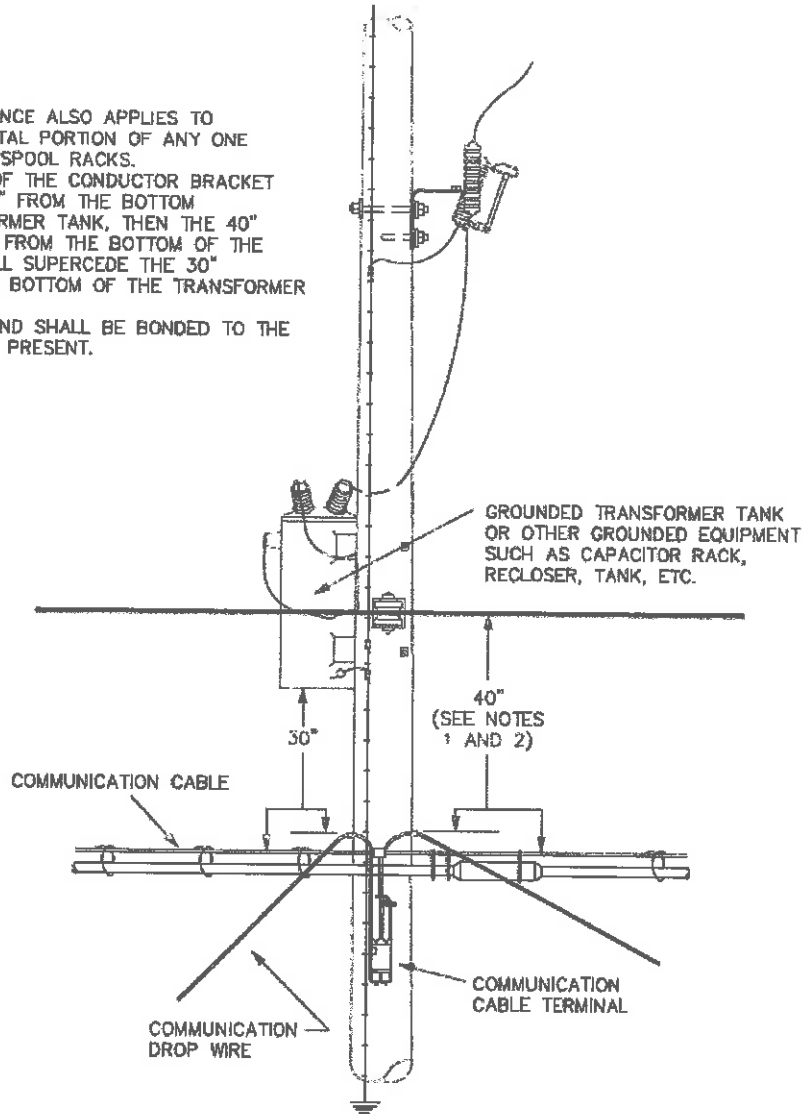

**TRANSFORMER POLE**



DATE: OCTOBER, 1992

REVISIONS JULY, 2001

**JU&C3**

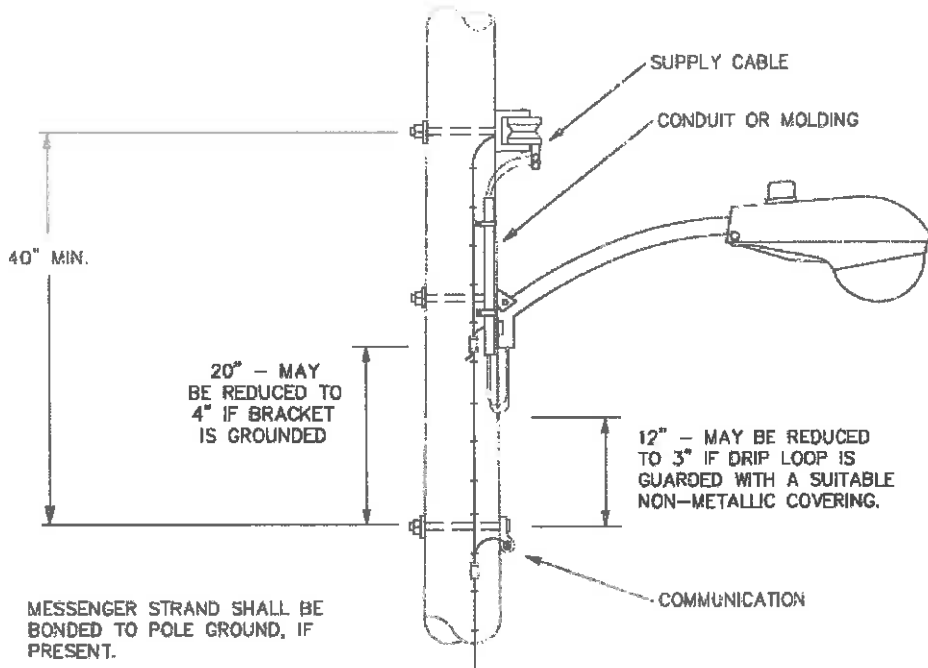

NOTES:

- 1.) LIGHT FIXTURE SHOWN IS SYMBOLIC ONLY. CLEARANCES SHOWN ARE APPLICABLE TO ANY TYPE FIXTURE USED.
- 2.) LOWEST PART OF LUMINAIRE SHALL BE NOT LESS THAN 15' OVER ROADS, STREETS, PARKING LOTS, OR ALLEYS.

**C.A.T.V., TELEPHONE, OTHER  
SEPARATION FROM LUMINAIRES**



REVISIONS JULY, 2002

**JU&C4**

DATE: OCTOBER, 1992

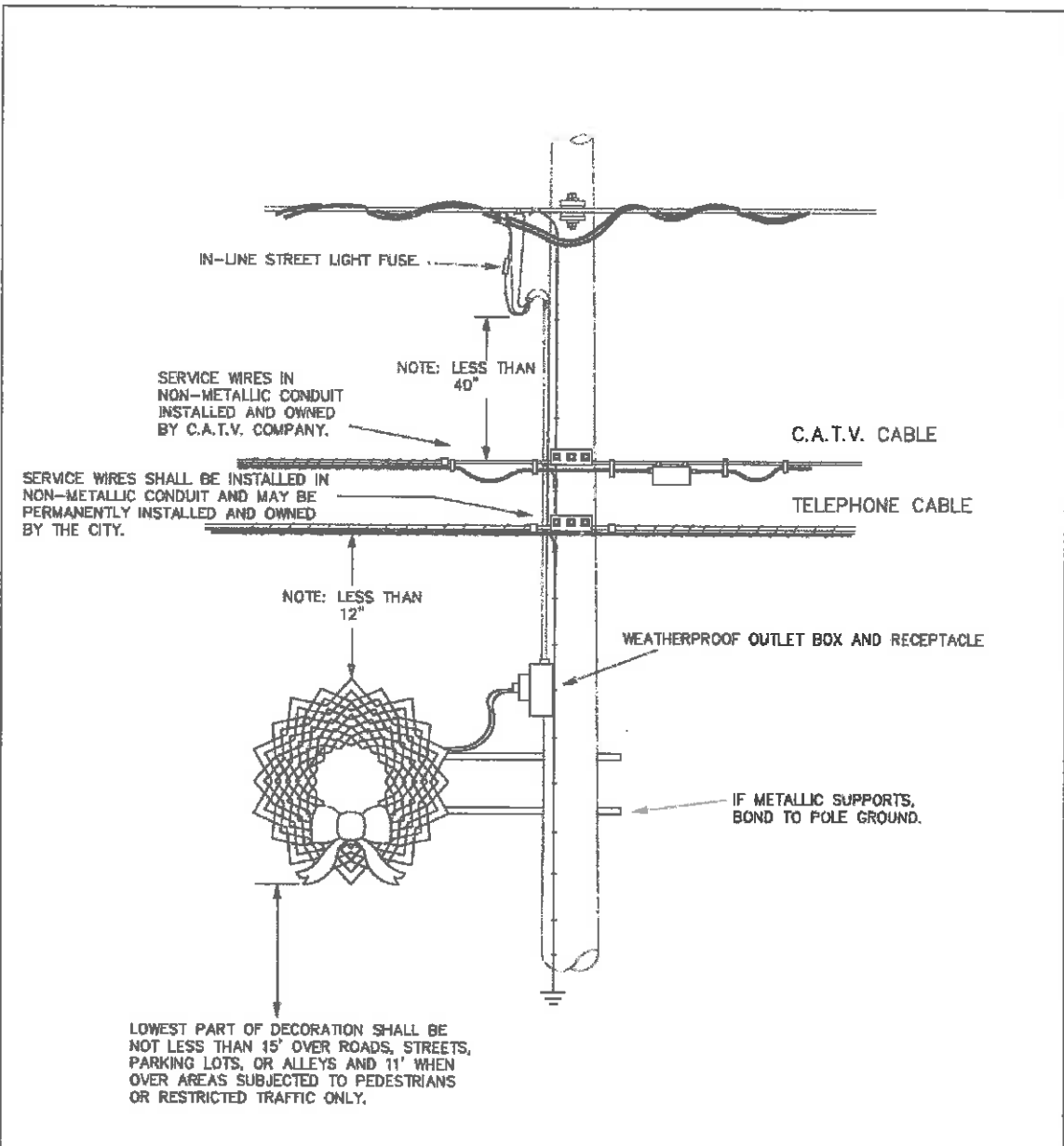

## DECORATIVE ATTACHMENT INSTALLATION

 <p style="font-size: small;">Electric Division of Georgia</p>	REVISIONS <u>JULY, 2001</u> <hr/> <hr/>	<b>JU&amp;C5</b>
DATE: <u>OCTOBER, 1992</u>		

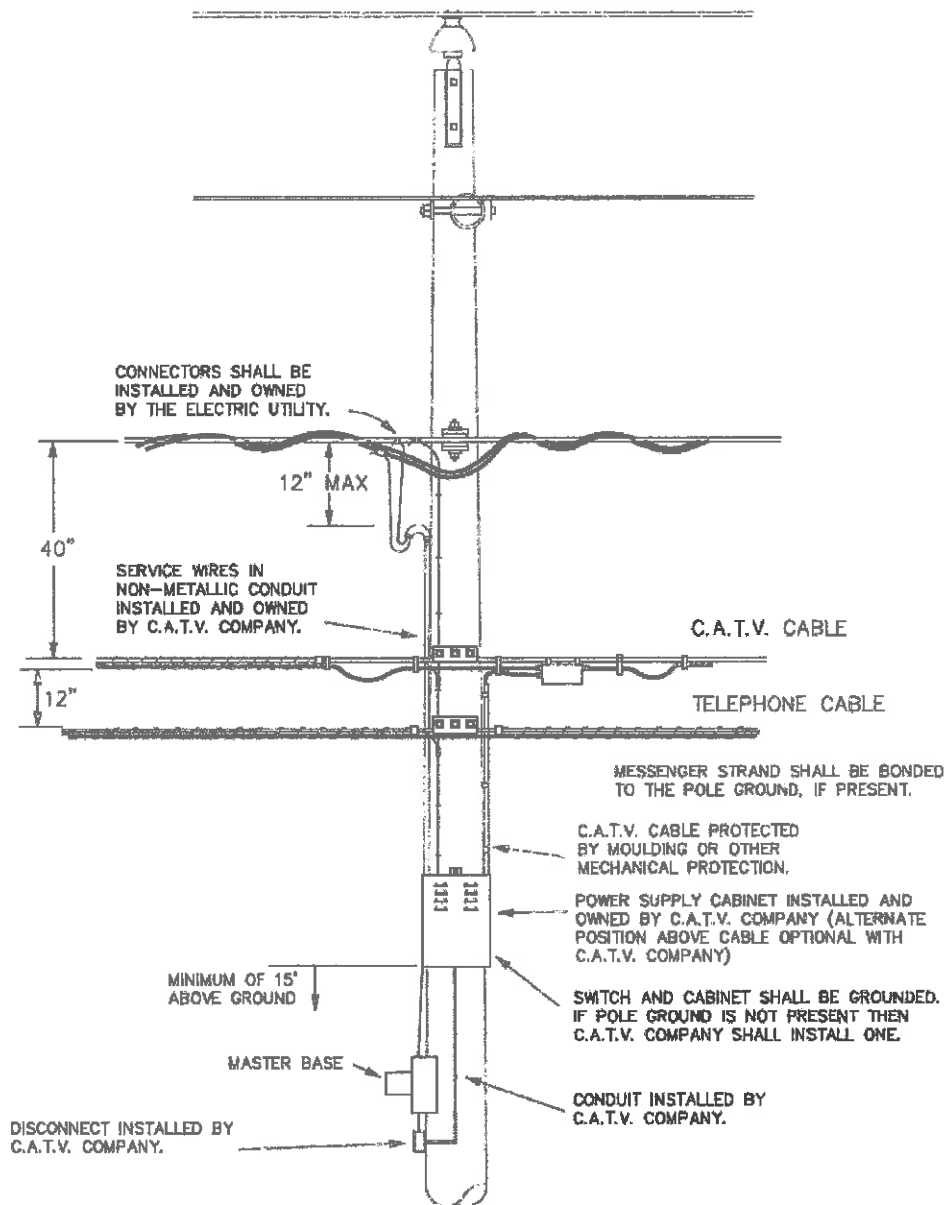

## **COMMUNICATION/SIGNAL TYPE ATTACHMENT C.A.T.V. POWER SUPPLY INSTALLATION**



DATE: OCTOBER, 1992

REVISIONS JULY, 2001

**JU&C6**

**\*COMMUNICATION/SIGNAL TYPE ATTACHMENT**

- TELEPHONE CABLE
- C.A.T.V. CABLE
- ALARM CABLE (FIRE, POLICE, WATER TOWER LEVEL, ETC.)
- TRAFFIC SIGNAL CONTROL CABLE
- TELEGRAPH CABLE
- PUBLIC OR PRIVATE COMMUNICATION CABLE

**NOTES:**

- 1.) WHEN C.A.T.V. AND TELEPHONE ARE ATTACHED TO POLE, C.A.T.V.'S PREFERRED POSITION IS ABOVE TELEPHONE (12" MIN.). IF OTHER COMMUNICATION/SIGNAL TYPE CABLES ARE ATTACHED TO POLE WITH C.A.T.V. AND/OR TELEPHONE, THEIR POSITION SHALL BE MUTUALLY AGREED UPON.
- 2.) 12" MIN. SPACING SHOULD BE MAINTAINED BETWEEN CABLES. C.A.T.V. AND TELEPHONE DROPS CAN BE LESS THAN 12" FROM OTHER CABLES. DROPS SHALL BE 40" BELOW POWER NEUTRAL OR SECONDARY AT POLE.
- 3.) ALL CABLES SHALL BE ON SAME SIDE OF POLE.
- 4.) MESSENGER STRAND SHALL BE BONDED TO POLE GROUND, IF PRESENT.

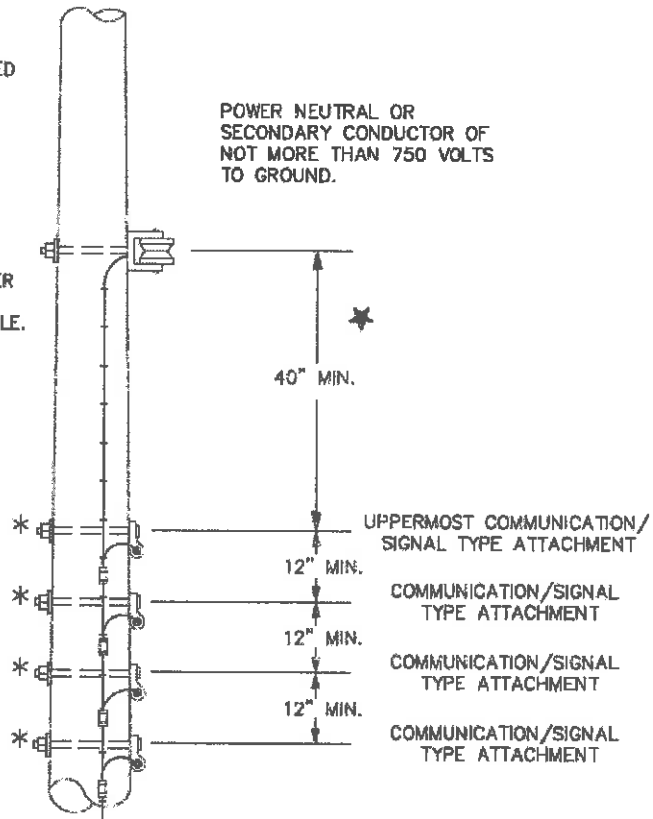

\* FOR SUPPLY NEUTRAL ONLY, THIS MAY BE REDUCED TO 30".

**MULTIPLE COMMUNICATION/SIGNAL TYPE ATTACHMENT**



DATE: OCTOBER, 1992

REVISIONS JULY, 2001

**JU&C7**

**FOOTNOTES TABLE 1:**

1. Where the height of a building or other installation does not permit service drops to meet these values, the clearances over residential driveways only may be reduced to the following:

	<u>FEET:</u>
a. Service drops limited to 300 V to ground	12.5
b. Service drip loops limited to 300 V to ground	10.5
c. Service limited to 150 V to ground	12.0
d. Drip loops only of service limited to 150 V to ground	10.0

2. Where the height of a building or other installation does not permit service drops to meet these values, the clearances may be reduced to the following:

	<u>FEET:</u>
a. Service drops, including drip loops, limited to 300 V to ground	10.5
b. Service drops, including drip loops, limited to 150 V to ground	10.0

3. Spaces and ways subject to pedestrians or restricted traffic only are those areas where equestrians, vehicles, or other mobile units, exceeding 8ft. in height, are prohibited by regulation or permanent terrain configurations or are otherwise not normally encountered or reasonably anticipated.

4. Where a supply or communication line along a road is located relative to fences, ditches, embankments, etc., so that the ground under the line would not be expected to be traveled except by pedestrians, the clearance may be reduced to the following values:

	<u>FEET:</u>
a. Insulated communications cables, neutrals, guys, and multiplex supply cables limited to 150 V to ground	9.5
b. Multiplex supply cables limited to 300 V to ground	12.5

5. This clearance may be reduced to 13 ft. for communication conductors and guys.

6. Where this construction crosses over or runs along alleys, driveways, or parking lots, this clearance may be reduced to 15 ft.

7. For controlled impoundments, the surface area and corresponding clearances shall be based upon the design high water level. For other waters, the service area shall be that enclosed by its annual high water mark, and clearances shall be based on the normal flood level. The clearance over rivers, streams, and canals shall be based upon the largest surface area of any 1 mi. long segment, which includes the crossing. The clearance over a canal, river, or stream normally used to provide access for sailboats to a larger body of water shall be the same as that required for the larger body of water.

9. For the purpose of this rule, trucks are defined as any vehicle exceeding 8 ft. in height. Areas not subject to truck traffic are areas where truck traffic is not normally encountered or not reasonably anticipated.

10. Communication cables and conductors may have a clearance of 15 ft. where poles are back of curbs or other deterrents to vehicular traffic.

Note: Footnote 8 and 11 were intentionally omitted

FOOTNOTES TABLE 1: (cont'd)

12. Where the U.S. Army Corps of Engineers, or the state or the surrogate thereof has issued a crossing permit, clearance of that permit shall govern.
13. For controlled impoundments, the surface area and corresponding clearance shall be based upon the design high water level. For other waters, the surface area shall be that enclosed by its annual high water mark, and clearances shall be based upon the largest surface area of any one mile long segment that includes the crossing. The clearance of a canal, river or stream normally used to provide access for sailboats to a larger body of water shall be the same as required for the larger body of water.
14. Where an over water obstruction restricts vessel height to less than the following:

Surface Area (Acres)	Reference Vessel Height (Feet)
less than 20	16
20 to 200	24
200 to 2000	30
over 2000	36

The required clearances may be reduced by the difference between the reference vessel height given above and the over water obstruction height, except that the reduced clearance shall not be less than that required for the surface area on the line crossing side of the obstruction.

The vertical clearance shall be maintained with the conductor at final sag and at the following condition whichever results in the greater vertical sag:

1. 32° F, no wind, with radial thickness of ice of 1/4 inch for medium loading and no ice for light loading.
- Or
2. The maximum conductor for which the line is designed to operate, if greater than 120° F.(120° F for all neutrals)

Note:

All clearances shown are design clearances under specified conditions, not measured clearances under ambient conditions.

<b>VOLTAGES ARE PHASE TO GROUND FOR EFFECTIVELY GROUNDED CIRCUITS</b>				
NATURE OF SURFACE UNDERNEATH WIRES, CONDUCTORS, OR CABLES	INSULATED COMMUNICATION CONDUCTORS AND CABLE; MESSENGERS; GROUNDED GUYS; SYSTEM NEUTRAL	DUPLEX, TRIPLEX, & QJADRAPLEX CABLE WITH GROUNDED GUYS; GROUNDED NEUTRAL 0 - 750 VOLTS	OPEN WIRE SECONDARY CONDUCTORS 0 - 750 VOLTS	OPEN WIRE CONDUCTORS OVER 750 VOLTS TO 22KV
	(IN FEET)	(IN FEET)	(IN FEET)	(IN FEET)
<b>WHERE WIRES, CONDUCTORS, OR CABLE CROSS OVER OR OVERHANG</b>				
1. TRACK RAILS OF RAILROADS.	23.5	24	24.5	25.5
2. ROADS, STREETS, AND OTHER AREAS SUBJECT TO TRUCK TRAFFIC. (SEE NOTE 4.)	15.5	16	16.5	18.5
3. DRIVEWAYS, PARKING LOTS, AND ALLEYS	15.5 (SEE NOTES 1 AND 6)	16 (SEE NOTES 1 AND 6)	16.5 (SEE NOTE 1)	18.5
4. OTHER LAND TRAVERSED BY VEHICLES SUCH AS CULTIVATED, GRAZING, FOREST, ORCHARD, ETC.	15.5	16	16.5	16.5
5. SPACES OR WAYS SUBJECT TO PEDESTRIAN OR RESTRICTED TRAFFIC ONLY. (SEE NOTE 3.)	9.5	12 (SEE NOTE 2)	12.5 (SEE NOTE 1)	14.5
6. WATER AREAS NOT SUITABLE FOR SAILBOATS OR WHERE SAILBOATS ARE PROHIBITED. (SEE NOTE 12.)	14	14.5	15	17
7. A) WATER AREAS (NOT REGULATED BY CORPS OF ENGR.) SUITABLE FOR SAILBOATS, INCLUDING LAKES, PONDS, RESERVOIRS, TIDAL WATERS, RIVERS, STREAMS, AND CANALS WITH AN UNOBSTRUCTED SURFACE AREA OF: A. LESS THAN 20 ACRES B. 20 TO 200 ACRES C. 200 TO 2000 ACRES D. OVER 2000 ACRES (SEE NOTES 12, 13, & 14.)	17.5 25.5 31.5 37.5	18 26 32 38	18.5 26.5 32.5 38.5	20.5 28.5 34.5 40.5
7. B) WATER AREAS REGULATED BY CORPS OF ENGINEERS (SEE NOTE 7)	52	55	55	55
8. PUBLIC OR PRIVATE LAND AND WATER AREAS POSTED FOR RIGGING OR LAUNCHING SAILBOATS.	CLEARANCE ABOVE GROUND SHALL BE 5 FEET GREATER THAN IN 7. ABOVE, FOR THE TYPE OF WATER AREAS SERVED BY THE LAUNCHING SITE.			
<b>WHERE WIRES, CONDUCTOR, OR CABLES RUN ALONG AND WITHIN THE LIMITS OF HIGHWAY OR OTHER ROAD RIGHT-OF-WAY BUT DO NOT OVERHANG THE ROADWAY</b>				
9. ROADS, STREET, OR ALLEYS	15.5 (SEE NOTES 6 AND 10)	15.5 (SEE NOTES 6)	16.5	18.5
10. ROADS IN RURAL DISTRICTS WHERE IT IS UNLIKELY THAT VEHICLES WILL BE CROSSING UNDER THE LINE.	15.5 (SEE NOTES 4 AND 5)	14.0 (SEE NOTES 4)	14.5 (SEE NOTES 4)	16.5
*ALWAYS REFER TO THE LATEST NESC (REFERENCE NESC RULE 232, 2007 EDITION, FOR ADDITIONAL INFORMATION)				
<b>VERTICAL CLEARANCES OF WIRES, CONDUCTORS, AND CABLES ABOVE GROUND, ROADWAYS, RAILS, OR WATER</b>				
		REVISIONS JULY, 2002		<b>TABLE 1</b>
DATE: OCTOBER, 1992				



**FOOTNOTES TABLE 2:**

1. Where a building, sign, chimney, antenna, tank, or other installation does not require maintenance such as painting, washing, changing of sign letters, or other operations which would require persons to work or pass between supply conductors or unguarded rigid live parts and structures, the clearance may be reduced by 2 ft.
3. A roof, balcony, or area is considered readily accessible to pedestrians if the means of access is through a doorway, ramp, window, stairway, or permanently mounted ladder. A permanently mounted ladder is not considered a means of access if its bottom rung is 8 ft. or more from the ground or other permanently installed accessible surface.
4. The required clearances shall be to the closest approach of motorized signs or moving portions of installations.
5. For the purpose of this rule, trucks are defined as any vehicle exceeding 8 ft. in height.
6. This clearance may be reduced to 3 in. for the grounded portions of the guys.
7. Windows not designed to open may have the clearance permitted for the walls and projections.
8. The horizontal clearance shall not be less than 3.5' plus the displacement of the conductor by a 6 lb/ft<sup>2</sup> wind at 60° F, final sag.
9. The horizontal clearance shall not be less than 4.5' plus the displacement of the conductor by a 6 lb/ft<sup>2</sup> wind at 60° F, final sag.
10. Where available space will not permit this value, the clearance may be reduced to 7.0 ft. for conductors limited to 8.7 KV to ground.

**Note:** Footnote 2 was intentionally omitted.



H - HORIZONTAL CLEARANCE  
T - TRANSITIONAL = VERTICAL (ARC)

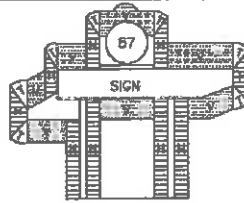

V - VERTICAL CLEARANCE

**VOLTAGES ARE PHASE TO GROUND FOR EFFECTIVELY GROUNDED CIRCUITS**

CLEARANCE FROM:	INSULATED COMMUNICATION CONDUCTORS AND CABLES; MESSENGERS; GROUNDED GUYS; NEUTRAL CONDUCTORS (IN FEET)	MULTIPLEX SUPPLY CABLE 0 - 750 VOLTS (IN FEET)	OPEN WIRE CONDUCTORS 0 - 750 VOLTS (IN FEET)	UNGUARDED RIGID LIVE PARTS OVER 750 VOLTS TO 22 KILOVOLTS (IN FEET)	OPEN WIRE CONDUCTORS OVER 750 VOLTS TO 22 KILOVOLT (IN FEET)
<b>1. BUILDINGS</b>					
<b>A. HORIZONTAL</b>					
(1) TO WALLS, PROJECTIONS, AND GUARDED WINDOWS.	4.5 (SEE NOTE 6)	5.0 (SEE NOTE 1)	5.5 (SEE NOTE 1 & 8)	7.0 (SEE NOTE 1)	7.5 (SEE NOTE 1,9,&10)
(2) TO UNGUARDED WINDOWS. (SEE NOTE 7)	4.5	5.0	5.5 (SEE NOTE 1 & 8)	7.0	7.5 (SEE NOTE 9 & 10)
(3) TO BALCONIES AND AREA ACCESSIBLE TO PEDESTRIANS. (SEE NOTE 3)	4.5	5.0	5.5 (SEE NOTE 8)	7.0	7.5 (SEE NOTE 9 & 10)
<b>B. VERTICAL</b>					
(1) OVER OR UNDER ROOF OR PROJECTIONS NOT READILY ACCESSIBLE TO PEDESTRIANS. (SEE NOTE 3)	3.0	3.5	10.5	12.0	12.5
(2) OVER OR UNDER BALCONIES AND ROOFS READILY ACCESSIBLE TO PEDESTRIANS. (SEE NOTE 3)	10.5	11.0	11.5	13.0	13.5
(3) OVER ROOFS ACCESSIBLE TO VEHICLES, BUT NOT SUBJECT TO TRUCK TRAFFIC. (SEE NOTE 5)	10.5	11.0	11.5	13.0	13.5
(4) OVER ROOFS ACCESSIBLE TO TRUCK TRAFFIC. (SEE NOTE 5)	15.5	16.0	16.5	18.0	18.5
<b>2. SIGNS, CHIMNEYS, BILLBOARDS, RADIO AND TELEVISION ANTENNAS, TANKS, AND OTHER INSTALLATIONS NOT CLASSIFIED AS BUILDINGS OR BRIDGES.</b>					
<b>A. HORIZONTAL; (SEE NOTE 4)</b>					
(1) READILY ACCESSIBLE	4.5	5.0	5.5	7.0	7.5
(2) NOT READILY ACCESSIBLE	3.0	3.5	5.5 (SEE NOTES 1 & 8)	7.0	7.5 (SEE NOTE 1,9,&10)
<b>B. VERTICAL</b>					
(1) OVER OR UNDER CATWALKS AND OTHER SURFACES UPON WHICH PERSONNEL WALK.	10.5	11.0	11.5	13.0	13.5
(2) OVER OR UNDER OTHER PORTIONS OF SUCH INSTALLATIONS.	3.0	3.5	6.0 (SEE NOTE 1)	7.5	8.0

\*ALWAYS REFER TO THE LATEST NESC  
(REFERENCE NESC RULE 232, 2007 EDITION, FOR ADDITIONAL INFORMATION)

**CLEARANCES OF WIRES, CABLES, AND UNGUARDED RIGID LIVE PARTS ADJACENT BUT NOT ATTACHED TO BUILDINGS AND OTHER INSTALLATIONS EXCEPT BRIDGES**



REVISIONS JULY, 2001

**TABLE 2**

DATE: OCTOBER, 1992

### Verizon Differences from Cingular Agreement

Article 2 - Added wording to the definitions to "Licensee" and "Licensor"  
Added "Wireless Facilities" term and definition

Article 4 - Paragraph A.3 – Added language to change inspection fees (now hourly) to fixed fees if mutually agreed to by both parties. Added language to specify a Make Ready Estimate needs to be submitted within 45 days of Licensee's application.  
- Paragraph A.10 – Added. Licensee is responsible for electric usage.

Article 6 – Added language to specify electric service providers' limited ability to grant Right of Way access.

Article 11 – Paragraph B.3 – Added. Licensee is entitled to dispute discrepancies found in the results of the Initial Inventory, Actual Inventory or discovery of Unauthorized Attachments.

Article 12 – Paragraph B. Added language to specify Licensee will not be obligated to pay rental fees if they remove all attachments.

Article 14 – Paragraph B. Added language that allows to terminate the Agreement in its entirety if default pertains to all poles or terminate permits for those Licensor locations in default.

Article 16 – Added language "...change of stock ownership, ... or grant of use in Licensee's facilities."

Article 19 – Paragraph B – added language to include electronic funds transfer for payment option.

Article 21 – Paragraph B – added language providing written request for dispute resolution above the local level.  
Paragraph H – added last sentence.

Article 22 – Paragraph B – changed 180 days to 150 days to remove attachments from poles, then 30 additional, then Licensor can remove.

Article 24 – Added language that Licensor must provide Licensee 60 days' notice of sale or transfer of system.

Article 25 – Insurance Requirements.

Exhibit 2 – Added placeholder for flat fees.





# Annual Budget - FY2020

July 1, 2019 - June 30, 2020

City Council Review - 4/15/19

Mayor Jerry D. Roseberry

Councilmembers

Jeff Wearing - Sarah Davis  
David Eady - George Holt  
Mike Ready - Jim Windham

Matthew Pepper, City Manager  
Connie Middlebrooks, City Clerk  
Dave Harvey, Police Chief  
Jody Reid, Supervisor of Public Works and Utilities

Act Number	Description	FY2018 Actual	FY2019 Budget	Thru Feb. 66.7%	FY 2019 Estimate	FY2020 Recommend	Comments
<b>GENERAL FUND - REVENUE</b>							
1 100-0000-311100-000	Real Property Tax-Current Yr.	95,908	95,000	103,821	95,000	110,000	Based on county growth
2 100-0000-311200-000	Property Tax - Prior Year	1,073	5,000	3,060	4,585	5,000	
3 100-0000-311300-000	Motor Vehicle Adv.	20,938	21,500	14,303	21,454	20,000	
4 100-0000-311345-000	Motor Vehicle TAVT	35,836	28,000	28,604	42,907	45,000	
5 100-0000-311340-000	Intangible Tax	3,629	4,900	2,080	3,120	3,000	
6 100-0000-311500-000	Real Estate Transfer	492	1,500	627	941	1,000	
7 100-0000-311710-000	Electric Franchise Tax	2,101	2,000	2,237	2,000	2,200	
8 100-0000-311730-000	Gas Franchise Tax	14,746	12,000	7,735	11,602	10,000	
9 100-0000-311750-000	TV Cable Franchise Tax	27,106	28,000	24,218	36,327	28,000	
10 100-0000-311760-000	Telephone Franchise Tax	4,440	6,800	0	6,800	4,500	
11 100-0000-313100-000	LOST Sales & Use Tax	355,635	340,000	261,409	340,000	360,000	Based on county-wide sales tax growth.
12 100-0000-316100-000	General Business License	11,605	12,000	10,600	12,000	11,500	
13 100-0000-316200-000	Insurance Premium Tax	141,828	141,000	152,453	152,453	161,000	One check per year, based on population.
14 100-0000-319000-000	Penalty/Interest on Del Taxes	741	1,200	943	1,414	1,300	
15 100-0000-322901-000	Misc. Income	97	1,000	2,881	4,322	1,500	
16 100-0000-333900-000	Intergovernmental Revenues	25,651	25,000	26,038	25,000	27,000	LMIG from GDOT
17 100-0000-341400-000	Printing/Duplicating Service	163	200	72	108	200	
18 100-0000-341910-000	Election Qualifying Fees	576	600	0	576	1,200	
19 100-0000-349100-000	Cemetery Fees	4,800	4,000	400	600	2,000	
20 100-0000-349900-000	Bad Check Fees	540	1,000	630	945	1,000	
21 100-0000-351000-000	Fines & Forfeitures	83,728	70,000	73,093	109,640	80,000	
22 100-0000-361000-000	Interest Revenues	29,283	6,500	39,952	59,927	50,000	
23 100-0000-381000-000	Rents and Royalties	550	1,500	0	1,500	1,500	
24 100-0000-381001-000	Lease Agreement Income	30,000	30,000	31,710	31,710	31,710	Whatcoat Building
25 100-0000-381002-000	Lease - Verizon	26,007	26,941	15,453	23,180	27,324	Water tower antenna - 2.5% annual increase.
26 100-0000-392300-000	Proceeds-Dispose of Assets	5	1,000	17,661	26,492	1,000	
	<b>REVENUES TOTAL</b>	<b>\$917,477</b>	<b>\$866,641</b>	<b>\$819,980</b>	<b>\$1,014,606</b>	<b>\$986,934</b>	

Acct Number	Description	FY2018 Actual	FY2019 Budget	Thru Feb.	FY 2019 Estimate	FY2020 Recommend	Comments
<b>GENERAL FUND - EXPENDITURES</b>							
<b>CITY COUNCIL</b>							
1 100.1100.511100.000	Regular Employees	32,400	34,800	20,000	30,000	34,800	
2 100.1100.512200.000	Social Security (FICA)	2,479	2,663	1,530	2,295	2,663	
3 100.1100.523100.000	Liability Insurance	11,171	12,000	12,000	12,000	12,000	annual bill in April.
4 100.1100.523600.000	Education & Training	2,688	3,000	1,667	2,501	6,000	Potentially 4 New Councilmembers
5 100.1400.511100.000	Reg Employees - Election	420	600	0	600	650	
	<b>SUBTOTAL</b>	<b>\$49,158</b>	<b>\$53,063</b>	<b>\$35,197</b>	<b>\$47,396</b>	<b>\$56,113</b>	

Acct Number	Description	FY2018 Actual	FY2019 Budget	Thru Feb.	FY 2019 Estimate	FY2020 Recommend	Comments
<b>GENERAL GOVERNMENT</b>							
1 :000.1500.511000.000	Regular Employees	197,762	235,717	157,934	236,901	221,249	
2 :000.1500.511300.000	Overtime	5,025	6,000	2,263	3,394	6,000	
3 :000.1500.512100.000	Group Insurance	49,073	70,452	36,367	54,551	60,454	
4 :000.1500.512200.000	Social Security (FICA)	15,700	18,415	12,292	18,437	17,385	
5 :000.1500.512400.000	Retirement Plan Expense	30,969	31,979	21,194	31,791	13,348	
6 :000.1500.512450.000	Retirement Cont. (DC) 401	3,817	7,332	3,572	5,358	9,679	
7 :000.1500.512700.000	Workers' Comp Insurance	713	1,000	733	1,100	1,500	
8 :000.1500.512900.000	Unemployment Payments	0	2,000	0	0	2,000	
9 :000.1500.521200.000	Professional	79,642	110,000	57,600	86,400	110,000	City Attorney, CPA firm, audit services, Tax Assessor's Office.
10 :000.1500.521200.001	Code Enforcement Services	0	5,000	2,315	3,473	5,000	Contract with Bureau Veritas.
11 :000.1500.521202.000	Fire Services - Newton County	21,570	22,000	23,871	23,871	25,000	one bill per year.
12 :000.1500.521300.000	Technical Purchased Service	40,504	40,700	33,533	40,700	42,500	
13 :000.1500.522000.000	Repairs & Maintenance	25,210	30,000	17,185	25,778	40,000	Building repairs (e.g. - touch up painting, plumbing, etc.)
14 :000.1500.522000.001	Wharcoat Building maintenance	0	5,000	225	338	5,000	
15 :000.1500.522200.002	YH Welcome Center	0	100,000	0	0	100,000	Welcome Center operations costs.
16 :000.1500.523100.000	Liability Insurance	12,029	10,000	0	10,000	10,000	annual bill in April.
17 :000.1500.523200.000	Telephone - Postage	21,899	24,000	16,462	24,693	25,000	
	Telephone System Upgrades					8,000	
18 :000.1500.523900.000	Advertising & Promotions	5,824	7,000	4,193	6,289	7,000	
19 :000.1500.523920.000	July 4th parade expenses	4,332	6,000	2,368	3,553	6,000	
20 :000.1500.523600.000	Dues & Fees	8,624	9,000	5,033	7,550	9,000	
21 :000.1500.523700.000	Education & Training	6,976	8,000	6,590	9,885	11,000	
22 :000.1500.531100.000	Supplies & Materials	15,408	18,000	13,290	19,935	19,000	
23 :000.1500.531200.000	Energy - Utilities	15,574	15,000	12,278	18,417	16,000	
24 :000.1500.531600.000	Small Equipment Under \$5,000	2,221	5,000	813	1,219	5,000	
25 :000.1500.531600.001	Computer Upgrades	0	10,000	9,298	10,000	16,600	Upgrade the firewall and server at City Hall.
	Security System Upgrades					7,000	Upgrade security system for City Hall (e.g. - upgrade current cameras, add new cameras, better monitoring system, etc.)
26 :000.1500.531700.000	Other/Meetings & Events	3,719	5,000	2,125	3,187	7,000	Potentially New Mayor
27 :000.1500.579000.000	Contingency - General	0	26,171	0	0	0	
28 :000.1500.579010.000	Contingencies - cash over & short	130	200	0	0	200	
	<b>SUBTOTAL</b>	<b>\$566,669</b>	<b>\$828,966</b>	<b>\$441,533</b>	<b>\$646,819</b>	<b>\$805,915</b>	



Acct Number	Description	FY2018 Actual	FY2019 Budget	Thru Feb.	FY 2019 Estimate	FY2020 Recommend	Comments
<b>COURT</b>							
1 100.2500.521200.000	Contract - Judge	5,000	5,000	3,750	5,000	5,000	
2 100.2500.521210.000	Contract - Public Defender	500	500	500	750	500	
3 100.2500.521211.000	Contract - Solicitor	2,400	4,800	4,800	4,800	4,800	
4 100.2500.523700.000	Education - Clerk	225	1,550	791	1,187	3,000	
5 100.2500.523701.000	Education - Judge	722	1,200	1,123	1,200	1,200	
5 100.2500.523850.000	Contract - Translator	175	200	0	0	200	
	<b>SUBTOTAL</b>	<b>\$9,022</b>	<b>\$13,250</b>	<b>\$10,964</b>	<b>\$12,937</b>	<b>\$14,700</b>	
<b>POLICE DEPARTMENT</b>							
7 100.3200.511000.000	Regular Employees	121,424	132,981	66,674	100,011	128,639	
8 100.3200.511300.000	Overtime	9,415	12,000	7,350	11,084	10,000	
9 100.3200.512100.000	Group Insurance	17,842	36,710	10,841	16,262	25,405	
10 100.3200.512200.000	Social Security (FICA)	10,012	11,091	5,666	8,499	10,460	
11 100.3200.512450.000	Retirement Cont. (DC) 401	4,568	6,930	2,477	3,716	6,749	
12 100.3200.512700.000	Workers' Comp Insurance	6,661	7,000	6,186	9,279	7,000	
13 100.3200.521300.000	Tech Purch Serv/Courtware	8,119	11,000	7,878	11,817	11,000	
14 100.3200.522200.000	Veh & Equip Repairs & Maint	12,312	9,000	8,882	9,000	10,000	
15 100.3200.523100.000	Liability Insurance	13,846	14,000	0	14,000	14,000	annual bill in April.
16 100.3200.523200.000	Telephone-Postage	6,736	5,500	4,935	7,402	5,500	
17 100.3200.523600.000	Dues & Fees	130	250	130	195	250	
18 100.3200.523700.000	Education & Training	1,723	2,000	1,240	1,860	2,000	
19 100.3200.523850.000	Subpoena fee	0	200	0	0	200	
							Increased volume of inmates brought in by city police officers.
20 100.3200.523900.000	Prisoner Housing & costs	11,730	12,000	7,350	11,025	12,000	
21 100.3200.531100.000	Supplies & Materials	2,898	5,500	3,056	4,584	5,500	
22 100.3200.531270.000	Gasoline	7,104	10,000	5,555	8,332	10,000	cost of fuel increased.
23 100.3200.531600.000	Small Equipment Under \$5,000	8,061	5,000	66	10,000	5,000	
24 100.3200.531600.001	Computer Upgrades	0	5,000	3,647	5,000	0	
25 100.3200.531700.000	Uniforms	2,816	5,000	1,121	4,800	5,000	
26 100.3200.571000.000	Training funds - Payable	17,050	20,000	22,053	21,000	20,000	
27 100.3600.342500.000	E-911 Center	32,154	22,500	41,224	22,500	43,000	
	<b>SUBTOTAL</b>	<b>\$294,603</b>	<b>\$333,562</b>	<b>\$206,372</b>	<b>\$280,368</b>	<b>\$331,704</b>	

Act Number	Description	FY2018 Actual	FY2019 Budget	Thru Feb.	FY 2019 Estimate	FY2020 Recommendation	Comments
<b>STREET DEPARTMENT</b>							
1 100.4200.511100.000	Regular Employees-Street	54,275	30,755	23,777	35,665	45,698	allocating 1/3 of meter reader; 3/5 of groundskeeper;
2 100.4200.511300.000	Overtime	1,488	1,000	960	1,440	1,000	1/5 equip operator
3 100.4200.512100.000	Employee Insurance	9,797	5,219	4,160	6,240	15,496	
4 100.4200.512200.000	Social Security (FICA)	4,626	2,429	1,604	2,405	3,496	
5 100.4200.512400.000	Retirement Plan Expense	9,921	2,060	1,385	2,077	0	
6 100.4200.512450.000	Retirement Cont. (DC) 401	859	1,443	423	634	2,682	
7 100.4200.512700.000	Workers' Comp Insurance	4,865	5,400	2,941	4,412	5,400	
8 100.4200.521201.000	Professional - Engineering	1,958	3,000	1,836	2,754	3,000	
9 100.4200.522200.000	Veh & Equip Repairs & Maint	10,121	11,000	7,621	11,432	12,000	
10 100.4200.523700.000	Education & Training	120	500	240	359	500	
11 100.4200.523850.000	Contract Labor - Temporary Help	47,306	12,026	8,930	13,394	13,104	
12 100.4200.531100.000	Supplies & Materials	13,275	13,000	11,864	17,796	15,000	
13 100.4200.531270.000	Gasoline/Diesel	7,159	4,000	5,080	7,620	4,000	cost of fuel increased.
14 100.4200.531600.000	Small Equipment Under \$5,000	400	1,500	0	0	1,500	
15 100.4200.531700.000	Uniforms	3,257	1,800	1,875	2,813	2,200	
16 100.4200.531800.000	Stormwater Management	7,000	5,500	2,000	5,500	7,000	KCNB contract for \$2,000
17 100.4200.531901.000	City Tree Removal	26,700	30,000	12,900	19,350	30,000	Trees continue to decline
18 100.4200.532100.000	Sidewalks	0	3,000	0	0	3,000	
	<b>SUBTOTAL</b>	<b>\$203,125</b>	<b>\$133,671</b>	<b>\$87,594</b>	<b>\$133,891</b>	<b>\$165,076</b>	

Acct Number	Description	FY2018 Actual	FY2019 Budget	Thru Feb.	FY 2019 Estimate	FY2020 Recommend	Comments
<b>PARKS AND RECREATION DEPARTMENT</b>							
1 100.6200.511100.000	Regular Employees - Parks & Rec.		10,515	5,252	7,878	20,827	allocating 2/5 of groundskeeper (2)
2 100.6200.511300.000	Overtime		500	0	0	500	
3 100.6200.512100.000	Group Insurance		137	109	163	7,160	
4 100.6200.512200.000	Social Security (FICA)		843	402	603	1,632	
5 100.6200.512450.000	Retirement Cont. (DC) 401		616	209	313	1,250	
6 100.6200.512700.000	Workers' Comp Insurance		1,000	358	538	1,000	
7 100.6200.523850.000	Contract Labor - Temporary Help		5,300	2,720	4,081	5,300	
8 100.6200.521200.000	Professional (arborist)	450	700	150	225	700	
9 100.6200.522200.000	Veh & Equip Repairs & Maint		1,000	0	0	1,000	
10 100.6200.531100.000	Supplies & Materials		2,000	48	72	2,000	
11 100.6200.531270.000	Gasoline/Diesel		1,400	752	1,127	1,400	cost of fuel increased.
12 100.6200.531700.000	Uniforms		650	432	649	950	
13 100.6200.531600.000	Small Equipment Under \$5,000		500	0	0	1,000	
14 100.6200.531900.000	Tree Board (pruning, planting, Arbor Day, arborist)	8,342	9,000	4,877	7,316	9,000	
15 100.6200.531910.000	City Park and Trail Maintenance	0	10,000	2,350	3,525	20,000	
	<b>SUBTOTAL</b>	\$8,792	\$25,250	\$17,659	\$12,914	\$73,719	
<b>CEMETERY</b>							
23 100.4900.522200.000	Cemetery Found. Maint. Suppl.	10,000	5,000	5,000	5,000	7,000	Foundation requesting \$7,000.
24 100.4900.531900.000	Tree Removal	4,800	5,000	4,800	5,000	5,000	
	<b>SUBTOTAL</b>	\$14,800	\$10,000	\$9,800	\$10,000	\$12,000	

Acct Number	Description	FY2018 Actual	FY2019 Budget	Thru Feb.	FY 2019 Estimate	FY2020 Recommend	Comments
<b>WATER &amp; SEWER FUND - REVENUES</b>							
1 505.4300.344210.000	Water Charges/Sales	507,618	510,000	342,512	513,758	510,000	
2 505.0000.344215.000	Water Tap Fees	5,902	10,000	13,173	15,000	10,000	
3 505.0000.344235.000	Sewer Charges/Sales	264,051	259,000	174,235	261,352	260,000	
4 505.0000.344256.000	Sewer Tap Fees	6,673	4,000	4,371	10,000	10,000	
5 505.0000.344280.000	Hydrant Meter	0	500	117	176	500	
	<b>TOTAL REVENUES</b>	<b>\$784,244</b>	<b>\$783,500</b>	<b>\$534,408</b>	<b>\$800,296</b>	<b>\$790,500</b>	
<b>WATER &amp; SEWER FUND - EXPENDITURES</b>							
6 505.4300.511100.000	Regular Employees	37,630	37,901	24,682	37,023	37,825	allocating 1/3 of meter reader/equip oper
7 505.4300.511300.000	Overtime	3,371	3,000	798	1,197	3,000	
8 505.4300.512100.000	Employee Insurance	8,956	12,572	8,682	13,022	11,922	
9 505.4300.512200.000	Social Security (FICA)	3,087	3,129	2,534	3,801	3,123	
10 505.4300.512400.000	Retirement Cont. (DC) 401	1,335	2,219	1,191	1,786	2,270	
11 505.4300.512700.000	Workers' Comp Insurance	1,681	2,500	2,669	4,004	2,800	
12 505.4300.521200.000	Legal & Professional	3,900	3,900	3,900	3,900	3,900	
13 505.4300.521300.000	Sewer Treatment Fees	122,975	120,000	81,590	122,386	123,000	
14 505.4300.522000.000	Veh & Equip Repairs & Maint	4,826	0	2,707	0	0	Split into four accounts below:
15 505.4300.522200.001	Service Contracts	15,041	16,000	11,558	17,337	16,000	Includes elevated tank and two lift stations.
16	Building Repairs		2,000	0	0	2,000	
17	Equipment Repair and Rental		1,500	0	0	1,500	
18	Vehicle Repairs		300	0	0	300	
19 505.4300.523100.000	Liability Insurance	1,833	1,500	0	2,000	1,500	annual bill in April.
20 505.4300.523200.000	Telephone-Postage	1,528	1,500	1,165	1,748	1,500	
21 505.4300.523600.000	Dues & Fees	1,161	1,300	1,515	2,273	1,300	Includes online bill pay fee.
22 505.4300.523700.000	Education & Training	3,797	2,500	1,323	1,985	3,000	Includes license fees
23 505.4300.523850.000	Contract Labor	8,525	25,000	4,300	6,450	20,000	
24 505.4300.531100.000	Materials & Supplies	19,469	22,000	16,546	24,819	22,000	
25 505.4300.531200.000	Energy - Utilities	2,374	1,900	1,752	2,628	1,900	
26 505.4300.531270.000	Gasoline/Diesel	3,712	4,400	2,765	4,148	5,000	cost of fuel increased.
27 505.4300.531510.000	Water for Resale	220,673	218,000	129,663	194,495	218,000	
28 505.4300.531600.000	Small Equipment Under \$5,000	0	3,000	0	0	3,000	
29 505.4300.531700.000	Uniforms	3,050	2,500	2,418	3,627	2,300	
30 505.4300.561000.000	Depreciation Expense	180,607	180,607	120,406	186,000	181,000	
31 505.4300.574000.000	Bad Debt Expense	5,763	7,000	0	0	7,000	
32 505.4300.582000.000	GEFA Loan Interest Payback	342	20,000	523	784	20,000	
33 505.4300.579000.000	Contingency	0	7,272	0	0	0	
	<b>TOTAL EXPENDITURES</b>	<b>\$655,635</b>	<b>\$703,500</b>	<b>\$422,688</b>	<b>\$635,413</b>	<b>\$695,140</b>	

Acct Number	Description	FY2018 Actual	FY2019 Budget	Thru Feb.	FY 2019 Estimate	FY2020 Recommend	Comments
<b>ELECTRIC FUND - REVENUES</b>							
1 510.0000.344310.000	Electric Sales	2,466,074	2,414,826	1,713,429	2,570,144	2,440,561	ECG estimate.
2 510.0000.344311.000	Penalties After the 15th	94,680	105,000	62,782	94,172	95,000	
3 510.0000.344312.000	Service Charges	6,250	6,000	4,850	7,275	6,000	
4 510.0000.361000.000	Interest Revenue	0	150	0	0	150	
5 510.0000.361001.000	Municipal Competitive Trust	6,287	64,260	4,355	6,532	0	
6 510.0000.381000.000	Other Rebates-Off System Sales	60,281	5,000	1,740	63,000	60,000	
	<b>TOTAL REVENUES</b>	<b>\$2,633,572</b>	<b>\$2,599,236</b>	<b>\$1,787,156</b>	<b>\$2,741,123</b>	<b>\$2,601,711</b>	
<b>ELECTRIC FUND - EXPENDITURES</b>							
7 510.4600.511100.000	Regular Employees	111,441	114,082	77,536	116,304	115,129	allocating 1/3 of meter reader/equip oper
8 510.4600.511300.000	Overtime	4,367	5,000	2,544	3,817	5,000	
9 510.4600.512100.000	Employee Insurance	16,314	22,606	15,342	23,013	33,528	
10 510.4600.512200.000	Social Security (FICA)	8,728	9,110	5,829	8,744	9,190	
11 510.4600.512400.000	Retirement Plan Expense	25,349	35,459	23,817	35,725	33,333	
12 510.4600.512450.000	Retirement Cont. (DC) 401	185	536	52	78	518	
13 510.4600.512700.000	Workers' Comp Insurance	1,388	2,000	1,624	2,436	2,000	
							ECG fees need to be shown separate from power costs. Adjusted estimate after ECG meeting - April 20 meeting.
14 510.4600.521200.000	ECG Professional Services	68,200	60,000	40,952	59,595	60,000	
15 510.4600.522200.000	Veh & Equip Repairs & Maint	8,601	7,200	4,323	6,485	7,200	
16 510.4600.522201.000	Power line Tree Trimming	21,922	35,000	1,393	2,089	35,000	
17 510.4600.523100.000	Liability Insurance	8,007	8,000	0	9,000	8,000	annual bill in April.
18 510.4600.523200.000	Telephone-Postage	7,675	8,000	6,743	10,115	8,000	
19 510.4600.523600.000	Dues & Fees	66	500	170	300	500	Fees for online bill paying.
20 510.4600.523700.000	Linemen Training	1,902	8,000	2,686	4,029	8,000	J. Benton's apprenticeship program.
21 510.4600.531100.000	Supplies & Materials	16,821	16,000	12,190	18,285	16,000	
22 510.4600.531200.000	Energy/Utilities	8,129	7,000	4,868	7,302	7,000	
23 510.4600.531270.000	Gasoline/Diesel	6,337	7,200	4,003	6,005	7,200	cost of fuel increased.
24 510.4600.531530.000	Electricity Purchased	1,421,969	1,455,316	978,318	1,467,477	1,460,081	ECG estimate.
25 510.4600.531600.000	Small Equipment Under \$5,000	1,873	2,500	0	0	2,500	
26 510.4600.531700.000	Uniforms	5,205	4,200	4,231	6,347	4,000	
27 510.4600.541004.000	Street Lights	2,280	1,500	2,280	3,420	2,300	
28 510.4600.561003.000	Depreciation	93,794	89,779	63,586	95,379	90,000	
29 510.4600.574000.000	Bad Debt Expense	0	25,500	7,720	11,580	25,500	
30 510.4600.579000.000	Contingency	0	6,488	0	0	0	
	<b>TOTAL EXPENDITURES</b>	<b>\$1,840,554</b>	<b>\$1,930,976</b>	<b>\$1,260,209</b>	<b>\$1,897,526</b>	<b>\$1,939,980</b>	

Acct Number	Description	FY2018 Actual	FY2019 Budget	Thru Feb.	FY 2019 Estimate	FY2020 Recommend	Comments
<b>SANITATION FUND - REVENUES</b>							
1	Refuse Collection Charges	148,589	169,050	112,913	169,370	169,050	
2	Sale of Recycled Materials	0	200	290	0	200	
	<b>TOTAL REVENUES</b>	<b>\$148,589</b>	<b>\$169,250</b>	<b>\$113,203</b>	<b>\$169,370</b>	<b>\$169,250</b>	
<b>SANITATION FUND - EXPENDITURES</b>							
3	Regular Employee - Sanitation		24,384	11,579	17,369	20,313	allocating 4/5 of equipment operator
4	Overtime		500	0	0	500	
5	Group Insurance		7,595	754	1,131	7,204	
6	Social Security (FICA)		1,904	886	1,329	1,592	
7	Retirement Plan Expense		8,350	5,538	8,307	0	
8	Retirement Cont. (DC) 401		1,300	236	354	1,219	
9	Workers' Comp Insurance		3,250	358	538	1,000	
10	Disposal Services-Landfill Fees	7,084	8,000	4,628	6,942	8,000	
11	Vehicle & Equip Repairs & Maint		3,000	0	0	5,000	
12	Supplies & Materials		1,000	56	84	2,000	
13	Contract Labor		16,773	10,992	16,488	20,966	
14	Gasoline/Diesel		5,000	1,204	1,806	5,000	cost of fuel increased.
15	Uniforms		1,300	363	545	950	
16	Small Equipment Under \$5,000		1,000	0	0	1,000	
17	Liability Insurance		3,000	0	0	3,000	
18	College Walk Dumpster Fees	6,650	6,700	4,433	6,650	6,700	
19	Contracted Garbage Pickup	67,633	82,850	53,876	80,814	82,000	
20	Dues & Fees	66	500	339	508	500	Fees for online bill paymg.
21	Bad Debt Expense	4,224	800	581	872	800	
22	Contingency	0	2,154	0	0	837	
	<b>TOTAL EXPENDITURES</b>	<b>\$85,657</b>	<b>\$179,359</b>	<b>\$95,824</b>	<b>\$143,736</b>	<b>\$168,582</b>	

**CITY OF OXFORD**

**RESOLUTION**

**WHEREAS**, the State of Georgia provides that the city can create a Capital Projects Fund, and

**WHEREAS**, City Council has determined that an Electric Capital Projects Fund will account for the financial resources to be used for the acquisition or construction of major capital facilities, projects, and motor vehicles related to the city's electric infrastructure and other than those financed by proprietary funds and trust funds,

**NOW THEREFORE BE IT RESOLVED THAT:**

- 1) The City Council of the City of Oxford does hereby establish an Electric Capital Projects Fund, and
- 2) The Electric Capital Projects Fund shall be used to accumulate resources for the acquisition, construction, or improvement of fixed assets and to acquire motor vehicles and equipment related to the city's electric infrastructure only, and
- 3) The City Manager shall as part of the annual budget, and from time to time, make recommendations to City Council for the use of the Electric Capital Projects Fund resources for approved purposes, and
- 4) The City Clerk and the City Manager shall submit to City Council an annual plan for the investment of the resources within the Electric Capital Projects Fund.

Adopted this 6<sup>th</sup> day of May, 2019.

BY:

\_\_\_\_\_  
Mayor

ATTEST:

\_\_\_\_\_  
City Clerk

LB





**CITY OF OXFORD**

**RESOLUTION**

**WHEREAS**, the State of Georgia provides that the city can create a Capital Projects Fund, and

**WHEREAS**, City Council has determined that a Water and Sewer Capital Projects Fund will account for the financial resources to be used for the acquisition or construction of major capital facilities, projects, and motor vehicles related to the city's water and sewer infrastructure and other than those financed by proprietary funds and trust funds,

**NOW THEREFORE BE IT RESOLVED THAT:**

- 1) The City Council of the City of Oxford does hereby establish a Water and Sewer Capital Projects Fund, and
- 2) The Water and Sewer Capital Projects Fund shall be used to accumulate resources for the acquisition, construction, or improvement of fixed assets and to acquire motor vehicles and equipment related to the city's water and sewer infrastructure only, and
- 3) The City Manager shall as part of the annual budget, and from time to time, make recommendations to City Council for the use of the Water and Sewer Capital Projects Fund resources for approved purposes, and
- 4) The City Clerk and the City Manager shall submit to City Council an annual plan for the investment of the resources within the Water and Sewer Capital Projects Fund.

Adopted this 6<sup>th</sup> day of May, 2019.

BY:

\_\_\_\_\_  
Mayor

ATTEST:

\_\_\_\_\_  
City Clerk

WC



OXFORD CAPITAL IMPROVEMENT PLAN 2020 - 2024 SCHEDULE

Capital Budget - 4/15/19

	PROJECT DESCRIPTION	Total Cost	FY2019	FY2019 YTD	FY2019 Balance	FY2020	FY2020	FY2021	FY2022	FY2023	FY2024	STWP
1	City Parks Design & Build	800,000	800,000	469,429	330,571	0	0	0	0	0	0	12
2	E. Clark Street Development	250,000	250,000	1,126	248,874	450,000	0	0	0	0	0	23,26
3	Moore Street Sidewalk	190,000	190,000	8,060	181,940	190,000	0	0	0	0	0	11
4	GEFA Sewer Extension - Emory St.	992,000	992,000	677,312	314,689	0	0	0	0	0	0	17
5	City Master Plan Develop & Implement	500,000	100,000	16,573	83,427	100,000	100,000	100,000	100,000	100,000	100,000	10,17,23
6	Downtown Development Authority	150,000	30,000	0	30,000	30,000	30,000	30,000	30,000	30,000	30,000	10,17,23
7	Electric System Improvements	575,000	160,000	0	160,000	100,000	100,000	100,000	100,000	100,000	100,000	
8	Storm Drainage Plans & Improvements	100,000	20,000	0	20,000	20,000	20,000	20,000	20,000	20,000	20,000	
9	Street Repairs and Resurfacing	600,000	100,000	15,645	84,355	100,000	150,000	100,000	100,000	150,000	100,000	
10	Pedestrian Bridge/Sidewalk	650,000	650,000	0	650,000	650,000	0	0	0	0	0	5,15
11	Sidewalks	500,000	100,000	14,924	85,076	100,000	100,000	100,000	100,000	100,000	100,000	15
12	Survey Remainder of City ROW	15,000	15,000	6,195	8,805	10,000	0	0	0	0	0	6,7
13	Pedestrian Crossing - Midblock at Asbury St. Park	47,000	47,000	0	47,000	75,000	0	0	0	0	0	15,21
14	Streets Dept. - Chipper Truck	84,000	84,000	79,044	4,956	0	0	0	0	0	0	
15	Yarborough House Renovation/Welcome Center	350,000	350,000	63,501	286,499	350,000	0	0	0	0	0	17
16	Welcome Center/City Trail Transportation	12,000	12,000	0	12,000	12,000	0	0	0	0	0	17
17	George Street Park Parking - Asbury Street	21,000	21,000	19,229	1,771	0	0	0	0	0	0	
18	Water Line Replacement - Queen Anne, etc.	190,000	0	0	0	190,000	0	0	0	0	0	
19	Water Main Replacement - Clark, Oxford, Hull, etc.	950,000	0	0	0	0	0	950,000	0	0	0	
20	Whatcoat Street Improvements	300,000	0	0	0	300,000	0	0	0	0	0	9
22	Electric Vehicle Charging Stations	24,000	0	0	0	0	0	24,000	0	0	0	
23	Smart Meters for Electric and Water	600,000	0	0	0	0	0	600,000	0	0	0	
24	Interconnect Walking Trails	600,000	0	0	0	300,000	200,000	100,000	100,000	100,000	0	11,12
25	Police Vehicles	105,000	0	0	0	0	0	35,000	35,000	35,000	0	
26	Public Works Vehicles & Equipment	178,000	0	0	0	0	0	150,000	28,000	0	0	
27	Water Main Replacement - Perry Circle	42,000	0	0	0	0	0	42,000	0	0	0	
28	Water Main Replacement - Keel Street, etc.	110,000	0	0	0	0	0	110,000	0	0	0	
NEW ITEMS FOR FY2020												
29	Public Works - Pickup Truck	28,000	0	0	0	0	0	28,000	0	0	0	
30	Water & Sewer Dept. - Back Hoe Tractor	71,126	0	0	0	71,126	0	0	0	0	0	
31	Streets Dept. - Lawn Mower	12,000	0	0	0	12,000	0	0	0	0	0	
32	Streets/P&R Dept. - RTV	14,500	0	0	0	14,500	0	0	0	0	0	
<b>TOTALS</b>		<b>9,060,626</b>	<b>3,921,000</b>	<b>1,371,038</b>	<b>2,549,962</b>	<b>3,074,626</b>	<b>2,639,000</b>	<b>613,000</b>	<b>635,000</b>	<b>450,000</b>		

SPLIST Funding Summary	
2011 SPLIST - Overage - Transportation	15,500
2017 SPLIST	
Water & Sewer - Water Main on Clark, Oxford, Emory St. Sewer Transportation	500,000
Transportation - street resurfacing in later years	400,000
Recreation - Asbury Street Park	100,000
Public Safety - Radio Upgrade & Future Vehicles	400,000
<b>2017 SPLIST Subtotal</b>	<b>1,500,965</b>

NEW ITEMS FOR FY2020	
29 Public Works - Pickup Truck	28,000
30 Water & Sewer Dept. - Back Hoe Tractor	71,126
31 Streets Dept. - Lawn Mower	12,000
32 Streets/P&R Dept. - RTV	14,500
<b>TOTALS</b>	<b>9,060,626</b>

Write-In Future Projects



***Over and Under Contractors, Inc.***

*Post Office Box 53 Sunnnee, Georgia 30024*

*Office (770) 682-9160 Fax (770) 682-1059 E-mail [overunde@bellsouth.net](mailto:overunde@bellsouth.net)*

City of Oxford  
110 W. Clark St.  
Oxford, GA 30054

ATTN: Jody Reed

RE: Changing Out Poles and Replace Equipment

Proposal for changing out poles, replacing equipment, and changing out conductors as per plans furnished by ECG. City of Oxford to furnish all materials. Over and Under will do this work for the lump sum of \$91,601.40.

Prices for each St. Work to be completed.

#1 West Clark St.	\$27,677.60
#2 Long St. Cir.	\$34,840.00
#3 Oxford N. Rd.	\$27,700.00
#4 Willow St.	\$13,833.80

Thank you for the opportunity to bid this work.

Sincerely

Jerry T. Blackwell

March 21, 2019

# MARABLE-PIRKLE INC.

PHONE # 404-344-4411

FAX # (404) 349-4096

April 9, 2019

City of Oxford Electrical  
Mr. Jody Reid  
jreid@oxfordgeorgia.org

FROM: Mike Pirkle

PROJECT: Oxford Electrical System Pole Replacement; W. Clark St, Oxford North Road,  
Williams St at Wesley and Longstreet Cir.

**COMMENTS:**

We appreciate the opportunity to provide the following proposal for the above referenced project.

MARABLE-PIRKLE, Inc. will furnish personnel and equipment to:  
Install new power poles and pole top assemblies to support the new pole installation.  
Transfer existing overhead electrical attachments as indicated on 4 ECG prints.

Pricing has been based on:  
Projects to run concurrently.  
Digging in soil/dirt rock and/or hand digging to be addressed on an hourly bases.  
Area to be accessible by trucks and trailer.  
All material to be furnished by the city.

Installations to be performed by experienced personnel to industry standards for the proposed pricing of;

W. Clark Street	\$40,740.00
Oxford North Road	\$31,405.00
Williams St at Wesley	\$15,452.00 (includes 635' of reconductoring)
Longstreet Circle	\$40,940.00

Projects will be accomplished by experienced, well trained personnel to the highest standards as reference letters state provided by other municipals.

Price qualifications and clarifications:  
Price firm for 30 days.  
Price based on normal working hours during straight time.  
Payment 30 day after invoice date. Past due Invoices are subject to late fee charges.

**BEFORE JOB CAN PROCEED WE MUST RECEIVE SIGNED & DATED ACCEPTANCE WITH  
PURCHASE ORDER # AS WELL AS LOCATE #**

ACCEPTED BY:

DATE

PURCHASE ORDER #

\_\_\_\_\_

\_\_\_\_\_

\_\_\_\_\_



Quote	10116695-00
Page	1
Date	03/01/19

**Quote Order**

**Sold To:** CITY OF OXFORD  
 110 W Clark St  
 Oxford, GA 30054-2274

**Shlp To:** CITY OF OXFORD  
 105 W Watson St  
 Oxford, GA 30054-2014

Customer PO		Warehouse	SLSP	Terms	Reference		Ship Via
Quote		Gresco-Forsyth, GA		Net 30 Days			Gresco Truck
Item Number / Description			Quantity	UM	Price	Per	Extension
2	<del>HDSO-88</del> CLAMP DE STRAIGHT.25-.88 2 BOLT SPRING LOADED		15	EA	13.25	EA	198.75
3	AR-0118 ROD ARMOR 1/0 SINGLE SUP AR-0118 #1/0 SS		50	EA	6.65	EA	332.50
5	3/8HSGUY500 WIRE GUY 3/8" HS 500'COI GALV STEEL CLASS A CLASS "A"		2500	FT	0.35	FT	875.00
6	D104-6 ANCHOR PISA 10" 6000# 3/4&1" RODS MID-STRENG		32	EA	21.50	EA	688.00
7	AHD-9B-1GX-3X1-3X ARR HD 9KV W/BKT WILDLIFE CAP SILICONE BZ HEAVY DUTY 9 KV RATED WITH ISOLATOR BRACKET, GROUND LEAD DISCONNECT, NO LINE OR GROUND LEAD, WILDLIFE CAP SILICONE BRONZE HARDWARE.		32	each	24.50	each	784.00
8	J9412 BOLT OVALEYE 5/8X12" 6" THREADS J9412 JOSLYN		25	EA	4.20	EA	105.00
9	RALS-1N CLAMP ANGLE SUS .23-.75 4-397.5 #RALS-1N/AAC-301		25	EA	9.50	EA	237.50
11	J9410 BOLT OVALEYE 5/8X10" 4" THREADS J9410 JOSLYN		50	EA	3.45	EA	172.50
12	J8812 BOLT MACHINE 5/8X12" 6" THREAD 2400/PALLET		100	EA	1.20	EA	120.00

**Continued**

Thank you for the opportunity to serve you!

88



Quote	10116695-00
Page	2
Date	03/01/19

Quote Order

Sold To: CITY OF OXFORD  
 110 W Clark St  
 Oxford, GA 30054-2274

Ship To: CITY OF OXFORD  
 105 W Watson St  
 Oxford, GA 30054-2014

Customer PO		Warehouse	SLIP	Terms	Ship via	
Quote		Gresco-Forsyth, GA		Net 30 Days	Gresco Truck	
Item Number / Description		Quantity	UM	Price	Per	Extension
13	D4503 BRACKET STEEL T 25KV FOR CUTOUT & ARRESTER 75 TO THE CRATE	32	EA	23.00	EA	736.00
15	J1626 CLEVIS SERVICE SWG 2"SPL J1626 JOSLYN K-11	100	EA	3.50	EA	350.00
18	F1CS-HV-V18-RHP-1 PIN CONDUCTOR SUPPORT RIDGE PIN	7	each	38.00	each	266.00
17	F2CS-HV-A48-VP-1 BRACKET FG 2PH VERT PIN INSULATOR BKT 1" THREAD 48"	2	each	98.00	each	196.00
18	C1530AP CLAMP HOTLINE AGP AL 6- 336.4 TAP6-3/0 ALL PURP	25	EA	10.75	EA	268.75
19	<del>C8G15-100A-113-CN-10KA</del> CUTOUT NON-LB 100A 15KV POLYMER PARALLEL GROOVE	32	each	58.50	each	1868.00
20	DG-4544 GRIP DIST DE 1/0 ACSR PREFORM 1/0 ACSR	50	EA	2.65	EA	132.50
21	GDE-1107 GRIP GUY DE GALV STEEL 3/8" PREFORM PRODUCT	200	EA	2.45	EA	490.00
22	U-112-SWB-PGE GRIP CABLE SUSPENSION LEWIS U-112-SWB-PGE	5	EA	14.75	EA	73.75
23	PG-MS-3921 GUY GUARD POLY 8' YELLOW PG-MS-3921	50	EA	2.40	EA	120.00

Continued

Thank you for the opportunity to serve you!





Quote Order

Quote	10116695-00
Page	3
Date	03/01/19

Sold To: CITY OF OXFORD  
 110 W Clark St  
 Oxford, GA 30054-2274

Ship To: CITY OF OXFORD  
 105 W Watson St  
 Oxford, GA 30054-2014

Customer PO		Warehouse	SLIP	Terms	Ship Via		
Quote		Gresco-Forsyth, GA		Net 30 Days	Gresco Truck		
Item Number / Description			Quantity	UM	Price	Per	Extension
25	MGA345 ATTACHMENT GUY MULTIPLE F/GUY WIRE & GUY STRAIN	50	EA	5.15	EA	267.50	
27	366S/PI23253RT INS PORC PIN 15KV F-NECK 1"R GRY 366-SPP 504/PLT	25	EA	6.50	EA	162.50	
28	J25255.1 BRACKET 1 POST INSULATOR MACLEAN	1	EA	18.00	EA	18.00	
30	RAVEN885R-FT-G COND ACSR 1/0 6/1RAVEN 885# REEL / 6095' 902035	6095	FT	0.27	FT	1645.65	
31	2012/VI2612 INS PORC SPOOL 3" 24/BX ANSI 53-2/C909-1032	72	EA	0.90	EA	64.80	
32	DEI-15 INS POLY SUSP DE 15KV SILICONE 240 PER PALLET	48	EA	9.60	EA	460.80	
33	GCTE15-54-08 INS GUY STRAIN 54"C-T 15000# FCTE1554 C-THIMBL MUST BE 5/8" RODS	5	EA	16.45	EA	82.25	
34	GCTE15-78-08 INS GUY STRAIN 78"C-T 15000# GCTE1578 C-THIMBL	40	EA	33.00	EA	1320.00	
37	J740Z PIN POLE TOP 15KV 1" NYLON HD 20"LG GALVSTL	20	EA	8.45	EA	169.00	
38	D75D ROD PISA 3/4X7 TW-EYE D75D DIXIE	35	EA	21.00	EA	735.00	

Continued

Thank you for the opportunity to serve you!



Quote Order

Quote	10116695-00
Page	4
Date	03/01/19

Sold To: CITY OF OXFORD  
 110 W Clark St  
 Oxford, GA 30054-2274

Ship To: CITY OF OXFORD  
 105 W Watson St  
 Oxford, GA 30054-2014

Customer PO		Warehouse	SLIP	Terms	Ship Via	Reference
Quote		Gresco-Forsyth, GA		Net 30 Days	Gresco Truck	
Item Number / Description	Quantity	UM	Price	Per	Extension	
39 <del>S08500/DF12L4</del> SCREW LAG 1/2X4 TWST PIL 5" HEAD EASY OUT	200	EA	0.63	EA	126.00	
40 S4425-1/0 STIRRUP BAIL HOT LINE 1/0 FOR H-TAP APPLICATION	50	EA	7.90	EA	395.00	
41 W588/615883 ROD GRD 5/8X8 CU NON-SEC 6258G13/615883/588RUS Interchange Prod: W588	5	EA	12.00	EA	60.00	
42 F1CS-MV-V13-RHP-1 PIN POLE TOP 1PH FBRGLS SUPPORT 1" PIN	7	each	23.00	each	161.00	
43 J25247.1 BOLT STUD 3/4-5/8 F/PST INS 1-3/4 LONG F/STL ARM	7	EA	3.15	EA	22.05	
45 WTF-0212 TIE WRAPLOCK 1/0 F-NECK WTF-0212 #1/0 PREFORM	50	EA	5.70	EA	285.00	
46 EZSP-4375 TIE EZ-WRAP SPOOL 1/0 PREFORM #1/0	100	EA	2.30	EA	230.00	
47 6SD.CU.TXR250C WIRE CU #8 SD INSULATED TXR SOLID RISER 250°C	250	FT	0.60	FT	150.00	
48 PM2-40 CABLE RISR SHLD PVC 2"X10' 1000/PLT	50	FT	1.80	FT	90.00	
49 CW44-6 WASHER SQUARE CURVED 4X4 - 5/8 & 3/4" CECO	50	EA	2.85	EA	142.50	

Continued

Thank you for the opportunity to serve you!



Quote	10116695-00
Page	5
Date	03/01/19

Quote Order

Sold To: CITY OF OXFORD  
 110 W Clark St  
 Oxford, GA 30054-2274

Ship To: CITY OF OXFORD  
 105 W Watson St  
 Oxford, GA 30054-2014

Customer PO		Warehouse	SLSP	Terms	Ship Via	
Quote		Gresco-Forsyth, GA		Net 30 Days	Gresco Truck	
Item Number / Description		Quantity	UM	Price	Per	Extension
50	AF1075 WASHER SQ 2-1/4X2-1/4X 3/16" W/11/16" HOLE250/B	250	each	0.30	each	75.00
51	6SD.CU315-FT WIRE CU #6 SD SPL BARE S 315' 25# SPL	315	FT	0.39	FT	122.85
52	C721N010KVA-D-E TX 7.2 120/240 1B 10KVA DOE CONV ERMCO NL28L179	1	EA	615.00	EA	615.00
53	C722N015KVA-D-E TX 7.2 120/240 2B 15KVA 15KVA	2	EA	665.00	EA	1330.00
54	C721N025KVA-D-E TX 7.2 120/240 1B 25KVA 25KVA NL69L409	2	EA	835.00	EA	1670.00
55	VERDC028DUT24N710KAPU* LIGHT LED 73W GREY T2 COMPLETE PART # VERDC028DUT24N710KAPU0215 SMALL COBRA HEAD	10	each	232.00	each	2320.00
45 Lines Total		Qty Shipped Total	11072	Total Invoice Total		20664.15
						20664.15
						11,658.00
						32,322.15

*plus poles*  
**Total** 32,322.15

Last Page

Thank you for the opportunity to serve you!

## Jody Reid

---

**From:** Cliff Stitcher <cliff.stitcher@gresco.com>  
**Sent:** Monday, March 11, 2019 9:46 AM  
**To:** Jody Reid  
**Cc:** Caleb Kirksey  
**Subject:** QUOTE FOR STREET JOBS  
**Attachments:** csti8558534.490b.Pdf

Good Morning Jody,

I hope you had a great weekend.

Please see attached quote and review it. We can make changes as needed before we make it an order if you choose to order this material. Pricing is good for 30 days and then we would have to re-quote as things change. Most of these are in stock but others have a 6 week lead time. I will list the pole pricing below.

Thank you for the opportunity.

Cliff

### Pole Pricing

QTY	TYPE	PRICE
1	CL 4-35 FT	\$148.00 EA
14	CL 3-40 FT	\$224.00 EA <u>#3,136</u>
18	CL 2-40 FT	\$259.00 EA <u>#4,662</u>
3	CL 3-45 FT	\$264.00 EA <u>#792</u>
8	CL 2-45 FT	\$319.00 EA <u>2,552</u>
1	CL 2-50 FT	\$368.00 EA

Total poles #11,658

# Quotation



STUART C IRBY BR743 KENNESAW  
 1025-A COBB INTERNATIONAL PLACE  
 SUITE A  
 KENNESAW GA 30152  
 770-422-1005 Fax 770-427-8455

QUOTE DATE	ORDER NUMBER
02/19/19	S011238122
REMIT TO: STUART C IRBY CO POST OFFICE BOX 741001 ATLANTA GA 30384	PAGE NO.  1

SOLD TO:  
 CITY OF OXFORD  
 110 W. CLARK STREET  
 OXFORD, GA 30054-2274

SHIP TO:  
 CITY OF OXFORD  
 110 W. CLARK STREET  
 OXFORD, GA 30054-2274  
 770-786-7004

ORDERED BY:

CUSTOMER NUMBER		CUSTOMER ORDER NUMBER		JOB/RELEASE NUMBER		OUTSIDE SALESPERSON	
128681						Gregory T Blankenshi	
INSIDE SALESPERSON		REQD DATE		FRGHT ALLWD		SHIP VIA	
Todd E Horto		02/19/19		No			
ORDER QTY	SHIP QTY	LINE	DESCRIPTION	Prc/UM	Ext Amt		
			***** Shipping Instructions *****				
			* ESTIMATE# 686 OXFORD LONG STREET	*			
			* <u>CIRCLE</u>	*			
			* -----	*			
			* LEAD TIME = STOCK-12WKS	*			
			* -----	*			
			*****				
20EA		1	MACL HDSO47 HOT LINE DEADEND CLAMP AL SIDE OPENING .19 -.47" #6-2/0 ACSR	11.200EA	224.00		
15EA		2	MACL HDSO-88 2/0-556 AL DE CLAMP	13.500EA	202.50		
750FT		3	GUY 3/8 UG CLS-A 250' COIL A475	320.000M	240.00		
12EA		4	MACL D104-6 10" HELIX ANCHOR FOR 3/4 -1" ROD STANDARD DUTY 6000# TORQUE RATING	24.250EA	291.00		
13EA		5	MACL ZHP010-0000000 10KV SRG ARST	34.750EA	451.75		
25EA		6	*POHA P9410 5/8 X 10 OVAL EYE BOLT	2.400EA	60.00		
100EA		7	*POHA P8812 5/8 X 12 MACHINE BOLT HO	1.150EA	115.00		
50EA		8	*POHA P8810 5/8 X 10 MACHINE BOLT	1.000EA	50.00		
13EA		9	*SFRM SF-12L SINGLE PHASE 25KV ARRESTER/CUTOUT T-BRACKET	14.950EA	194.35		
24EA		10	*POHA P1300 DEAD END CEVIS HOT DIP G	3.500EA	84.00		
25EA		11	BLAC HLC2108 HOT LINE CLAMP	7.400EA	185.00		
13EA		12	*POHA SIL115-195-PN 15KVA CUTOUT WITH PARALLEL GROVE CLAMP AND NEMA BRKT	61.750EA	802.75		
50EA		13	*HELI HD-522 DEADEND DIST GRIP	2.250EA	112.50		
***	Continued	on	Next Page ***				

\*\* Repr Int \*\* Repr Int \*\* Repr Int \*\*

8C



STUART C IRBY BR743 KENNESAW  
 1025-A COBB INTERNATIONAL PLACE  
 SUITE A  
 KENNESAW GA 30152  
 770-422-1005 Fax 770-427-8455

Quotation

QUOTE DATE	ORDER NUMBER
02/19/19	S011238122
REMIT TO: STUART C IRBY CO POST OFFICE BOX 741001 ATLANTA GA 30384	PAGE NO.  2

SOLD TO:  
 CITY OF OXFORD  
 110 W. CLARK STREET  
 OXFORD, GA 30054-2274

SHIP TO:  
 CITY OF OXFORD  
 110 W. CLARK STREET  
 OXFORD, GA 30054-2274  
 770-786-7004

ORDERED BY:

CUSTOMER NUMBER		CUSTOMER ORDER NUMBER		JOB/RELEASE NUMBER		OUTSIDE SALESPERSON	
128681						Gregory T Blankenshi	
INSIDE SALESPERSON		REQD DATE		FREIGHT ALLMD		SHIP VIA	
Todd E Horto		02/19/19		No			
ORDER QTY	SHIP QTY	LINE	DESCRIPTION	Prc/UOM	Ext Amt		
100EA		14	*HELI HG-210-3/8 DEADEND GUY GRIP	2.600EA	260.00		
1EA		15	*CEMO 70380343 CM WILDLIFE BIRDCUARD	4.250EA	4.25		
25EA		16	*ELEM 707YTIE 8' YELLOW GUY GUARD	2.400EA	60.00		
50EA		17	MACL J6555 5/8 GUY ATTACHMENT MALLEABLE STEEL 50/BOX	4.750EA	237.50		
24EA		18	*POPR 366-S LOW VLG PINTYPE INSLT ANSI 55-4	390.000C	93.60		
50EA		19	*POHA P532G P53-2G POWER LINE	0.580EA	29.00		
18EA		20	*POHA P8215-S 15KV POLYMER SUSPENSION INSULATOR	8.950EA	161.10		
20EA		21	MACL GCC1578R2 CLEVIS W/2 ROLLERS	27.650EA	553.00		
50EA		22	*PEUN GSE-C1-TN TRANSFORMER GROUNDING LUG; TIN PLATED	1.900EA	95.00		
10EA		23	*AMEL 115-15S-RN-120-R2-DA-EC 150 WATT HPS 120V COBRAHEAD LUMINAIRE W/ PER; ENCAPSULATED PLUG-IN CAPACITOR, GRAY IN COLOR	69.500EA	695.00		
1EA		24	*GE QAMW754 (5501AB0015) 15KVA XFM 1PH CONV POLE-MT HV: 7200/12470Y LV: 120/240 2-BUSH	582.000EA	582.00		
15EA		25	MACL J740Z PIN PT W/NA THD	8.250EA	123.75		
12EA		26	MACL D75D 3/4X7 TWINEYE ANCHOR ROD	22.500EA	270.00		
200EA		27	MACL J8754TP 1/2X4 LAG SCREW TWIST DRIVE, DRIVE POINT	0.690EA	138.00		
50EA		28	MACL HLS-2/0 HL STIRRUP	11.250EA	562.50		
25EA		29	MACL D6562A ANCHOR EYENUT POWER SCREW	8.750EA	218.75		
*** Continued on Next Page ***							



STUART C IRBY BR743 KENNESAW  
 1025-A COBB INTERNATIONAL PLACE  
 SUITE A  
 KENNESAW GA 30152  
 770-422-1005 Fax 770-427-8455

Quotation

QUOTE DATE	ORDER NUMBER
02/19/19	S011238122
REMIT TO: STUART C IRBY CO POST OFFICE BOX 741001 ATLANTA GA 30384	PAGE NO. 3

SOLD TO:  
 CITY OF OXFORD  
 110 W. CLARK STREET  
 OXFORD, GA 30054-2274

SHIP TO:  
 CITY OF OXFORD  
 110 W. CLARK STREET  
 OXFORD, GA 30054-2274  
 770-786-7004

ORDERED BY:

CUSTOMER NUMBER		CUSTOMER ORDER NUMBER		JOB/RELEASE NUMBER		OUTSIDE SALESPERSON	
128681						Gregory T Blankenshi	
INSIDE SALESPERSON		REQD DATE		FRIGHT ALLWD		SHIP VIA	
Todd E Horto		02/19/19		No			
ORDER QTY	SHIP QTY	LINE	DESCRIPTION	Prc/UOM	Ext Amt		
250FT		30	COND 6 SD POLY RISER SOL TRANS 250FT	540.000M	135.00		
50EA		31	MACL CW-44-6 4X4 CURV WASHER	2.800EA	140.00		
200EA		32	MACL J1075 3/16X2-1/4 SQ WASHER 11/16 HOLE	0.300EA	60.00		

~~27,089.75~~  
 plus poles \$ 11,658  
 Total project materials \$ 38,747.75

\* This is a quotation \*

Prices firm for acceptance within 30 days with the exception of commodity prices which are subject to change daily. Quotation is void if changed. Complete quote must be used unless authorized in writing.

For Terms and Conditions, Please See our website.

Subtotal	7431.30
S&F CHGS	0.00
Sales Tax	0.00
<b>TOTAL</b>	<b>7431.30</b>

\*\* Reprint \*\* Reprint \*\* Reprint \*\*



**Quotation**

STUART C IRBY BR743 KENNESAW  
 1025-A COBB INTERNATIONAL PLACE  
 SUITE A  
 KENNESAW GA 30152  
 770-422-1005 Fax 770-427-8455

QUOTE DATE	ORDER NUMBER
02/19/19	S011238132
REMIT TO: STUART C IRBY CO POST OFFICE BOX 741001 ATLANTA GA 30384	PAGE NO.  1

**SOLD TO:**  
 CITY OF OXFORD  
 110 W. CLARK STREET  
 OXFORD, GA 30054-2274

**SHIP TO:**  
 CITY OF OXFORD  
 110 W. CLARK STREET  
 OXFORD, GA 30054-2274  
 770-786-7004

**ORDERED BY:**

CUSTOMER NUMBER	CUSTOMER ORDER NUMBER	JOB/RELEASE NUMBER	OUTSIDE SALESPERSON		
128681			Gregory T Blankenshi		
INSIDE SALESPERSON	REQD DATE	FRIGHT ALLWD	SHIP VIA		
Todd E Horto	02/19/19	No			
ORDER QTY	SHIP QTY	LINE	DESCRIPTION	Prc/UOM	Ext Amt
			***** Shipping Instructions *****		
			* ESTIMATE# 683 OXFORD NORTH ROAD	*	
			* LEAD TIME = STOCK-12WKS	*	
			*****		
25EA		1	MACL RALS-1N #4 ANGLE SUSP CL	11.400EA	285.00
20EA		2	MACL HDSO47 HOT LINE DEADEND CLAMP AL SIDE OPENING .19 -.47" #6-2/0 ACSR	11.200EA	224.00
750FT		3	GUY 3/8 UG CLS-A 250' COIL A475	320.000M	240.00
12EA		4	MACL D104-6 10" HELIX ANCHOR FOR 3/4 -1" ROD STANDARD DUTY 6000# TORQUE RATING	24.250EA	291.00
10EA		5	MACL ZHP010-0000000 10KV SRG ARST	34.750EA	347.50
25EA		6	*POHA P9410 5/8 X 10 OVAL EYE BOLT	2.400EA	60.00
25EA		7	*POHA P9412 5/8 X 12 OVAL EYE BOLT	2.500EA	62.50
50EA		8	MACL J8812 5/8X12 MACHINE BOLT	1.220EA	61.00
10EA		9	MACL J25255.1 BRKT LINE POST	17.150EA	171.50
10EA		10	*SFRM SF-12L SINGLE PHASE 25KV ARRESTER/CUTOUT T-BRACKET	14.950EA	149.50
24EA		11	*POHA P1300 DEAD END CEVIS HOT DIP G	3.500EA	84.00
10EA		12	*POHA SIL115-195-PN 15KVA CUTOUT WITH PARALLEL GROVE CLAMP AND NEMA BRKT	61.750EA	617.50
50EA		13	*HELI HD-522 DEADEND DIST GRIP	2.250EA	112.50
100EA		14	*HELI HG-210-3/8 DEADEND GUY GRIP	2.600EA	260.00
*** Continued on Next Page ***					





**Quotation**

**STUART C IRBY BR743 KENNESAW  
1025-A COBB INTERNATIONAL PLACE  
SUITE A  
KENNESAW GA 30152  
770-422-1005 Fax 770-427-8455**

QUOTE DATE	ORDER NUMBER
02/19/19	S011238132
REMIT TO:	PAGE NO.
STUART C IRBY CO POST OFFICE BOX 741001 ATLANTA GA 30384	2

**SOLD TO:  
CITY OF OXFORD  
110 W. CLARK STREET  
OXFORD, GA 30054-2274**

**SHIP TO:  
CITY OF OXFORD  
110 W. CLARK STREET  
OXFORD, GA 30054-2274  
770-786-7004**

**ORDERED BY:**

CUSTOMER NUMBER	CUSTOMER ORDER NUMBER	JOB/RELEASE NUMBER	OUTSIDE SALESPERSON		
128681			Gregory T Blankenshi		
INSIDE SALESPERSON	REQD DATE	FRGHT ALLMD	SHIP VIA		
Todd E Horto	02/19/19	No			
ORDER QTY	SHIP QTY	LINE	DESCRIPTION	Prc/UOM	Ext Amt
3EA		15	*DCDD 00800-098 SUPPORT GRIP FOR 1.00-1.24" CABLE	27.650EA	82.95
25EA		16	*ELEM 707YTIE 8' YELLOW GUY GUARD	2.400EA	60.00
50EA		17	MACL J6555 5/8 GUY ATTACHMENT MALLEABLE STEEL 50/BOX	4.750EA	237.50
12EA		18	*POPR 366-S LOW VLG PINTYPE INSLT ANSI 55-4	390.000C	46.80
50EA		19	*POHA P532G P53-2G POWER LINE	0.580EA	29.00
18EA		20	*POHA P6215-S 15KV POLYMER SUSPENSION INSULATOR	6.950EA	161.10
10EA		21	MACL GCC15-60R2 GUY STRAIN INSULATOR 15000# 60" LONG WITH ROLLER ON EACH END	27.500EA	275.00
20EA		22	MACL GCC1578R2 CLEVIS W/2 ROLLERS	27.650EA	553.00
200EA		23	MACL J3316P 4-3/4 DRIVE HOOK	0.850EA	170.00
15EA		24	MACL J740Z PIN PT W/NA THD	8.250EA	123.75
11EA		25	MACL D75D 3/4X7 TWINEYE ANCHOR ROD	22.500EA	247.50
200EA		26	MACL J8754TP 1/2X4 LAG SCREW TWIST DRIVE, DRIVE POINT	0.690EA	138.00
500EA		27	*ELEM 106 LAG SCREW 1/4" X 2" UGUARD FASTNER	0.150EA	75.00
100EA		28	MACL J25247.1 SHRT LINE POST STUD 5/8 X 1-3/4"	3.250EA	325.00
25EA		29	MACL D6562A ANCHOR EYENUT POWER SCREW	8.750EA	218.75
*** Continued on Next Page ***					

# Quotation



STUART C IRBY BR743 KENNESAW  
 1025-A COBB INTERNATIONAL PLACE  
 SUITE A  
 KENNESAW, GA 30152  
 770-422-1005 Fax 770-427-8455

QUOTE DATE	ORDER NUMBER
02/19/19	S011238132
REMIT TO:	PAGE NO.
STUART C IRBY CO POST OFFICE BOX 741001 ATLANTA GA 30384	3

SOLD TO:  
 CITY OF OXFORD  
 110 W. CLARK STREET  
 OXFORD, GA 30054-2274

SHIP TO:  
 CITY OF OXFORD  
 110 W. CLARK STREET  
 OXFORD, GA 30054-2274  
 770-786-7004

ORDERED BY:

CUSTOMER NUMBER		CUSTOMER ORDER NUMBER		JOB/RELEASE NUMBER		OUTSIDE SALESPERSON	
128681						Gregory T Blankenshi	
INSIDE SALESPERSON			REQD DATE	FRGHT ALLWD	SHIP VIA		
Todd E Horto			02/19/19	No			
ORDER QTY	SHIP QTY	LINE	DESCRIPTION		Prc/UOM	Ext Amt	
5LN		30	*ELEM PEZUG10ST U-GUARD 2" X 10FT HDPE (1500' PER PALLET) (PRICE PER LENGTH) (ALT UOM PER FT) (1LN=10FT) (1EA=1 LENGTH)		9.250LN	46.25	
50EA		31	MACL CW-44-6 4X4 CURV WASHER		2.800EA	140.00	
200EA		32	MACL J1075 3/16X2-1/4 SQ WASHER 11/16 HOLE		0.300EA	60.00	

**\* This is a quotation \***

Prices firm for acceptance within 30 days with the exception of commodity prices which are subject to change daily. Quotation is void if changed. Complete quote must be used unless authorized in writing.

For Terms and Conditions, Please See our website.

Subtotal	5955.60
S&H CHGS	0.00
Sales Tax	0.00
<b>TOTAL</b>	<b>5955.60</b>

\*\* Reprint \*\* Reprint \*\* Reprint \*\*



Quotation

STUART C IRBY BR743 KENNESAW  
 1025-A COBB INTERNATIONAL PLACE  
 SUITE A  
 KENNESAW GA 30152  
 770-422-1005 Fax 770-427-8455

QUOTE DATE	ORDER NUMBER
02/19/19	S011238137
REMIT TO: STUART C IRBY CO POST OFFICE BOX 741001 ATLANTA GA 30384	PAGE NO.  1

SOLD TO:  
 CITY OF OXFORD  
 110 W. CLARK STREET  
 OXFORD, GA 30054-2274

SHIP TO:  
 CITY OF OXFORD  
 110 W. CLARK STREET  
 OXFORD, GA 30054-2274  
 770-786-7004

ORDERED BY:

CUSTOMER NUMBER	CUSTOMER ORDER NUMBER	JOB/RELEASE NUMBER	OUTSIDE SALESPERSON		
128681			Gregory T Blankenshi		
INSIDE SALESPERSON	REQD DATE	FRIGHT ALLMD	SHIP VIA		
Todd E Horto	02/19/19	No			
ORDER QTY	SHIP QTY	LINE	DESCRIPTION	Prc/UOM	Ext Amt
			***** Shipping Instructions ***** * ESTIMATE# 579 OXFORD WILLIAMS ST * * LEAD TIME = STOCK - 12WKS * *****		
20EA		1	MACL HDSO47 HOT LINE DEADEND CLAMP AL SIDE OPENING .19 -.47" #6-2/0 ACSR	11.200EA	224.00
50EA		2	*HELI AAR-522 ARMOR ROD 1/0-6/1 ACSR 52" LONG 50/BOX	5.950EA	297.50
250FT 4EA		3	GUY 3/8 UG CLS-A 250' COIL A475	320.000M	80.00
		4	MACL D104-6 10" HELIX ANCHOR FOR 3/4 -1" ROD STANDARD DUTY 6000# TORQUE RATING	24.250EA	97.00
5EA		5	MACL ZHP010-0000000 10KV SRG ARST	24.250EA	121.25
25EA		6	*POHA P9412 5/8 X 12 OVAL EYE BOLT	2.500EA	62.50
50EA		7	*POHA P8812 5/8 X 12 MACHINE BOLT HO	1.220EA	61.00
5EA		8	*SFRM SF-12L SINGLE PHASE 25KV ARRESTER/CUTOUT T-BRACKET	14.950EA	74.75
12EA		9	*POHA P1300 DEAD END CEVIS HOT DIP G	3.500EA	42.00
25EA		10	BLAC HLC2108 HOT LINE CLAMP	7.400EA	185.00
50EA		11	MACL ACTS-084 CIMP TOP INSL CIMP	9.350EA	467.50
5EA		12	*POHA SIL115-195-PN 15KVA CUTOUT WITH PARALLEL GROVE CLAMP AND NEMA BRKT	61.750EA	308.75
50EA		13	*HELI HD-522 DEADEND DIST GRIP	2.250EA	112.50
***	Continued	on	Next Page ***		



**Quotation**

**STUART C IRBY BR743 KENNESAW  
1025-A COBB INTERNATIONAL PLACE  
SUITE A  
KENNESAW GA 30152  
770-422-1005 Fax 770-427-8455**

QUOTE DATE	ORDER NUMBER
02/19/19	S011238137
REMIT TO: STUART C IRBY CO POST OFFICE BOX 741001 ATLANTA GA 30384	PAGE NO.  2

**SOLD TO:  
CITY OF OXFORD  
110 W. CLARK STREET  
OXFORD, GA 30054-2274**

**SHIP TO:  
CITY OF OXFORD  
110 W. CLARK STREET  
OXFORD, GA 30054-2274  
770-786-7004**

**ORDERED BY:**

CUSTOMER NUMBER		CUSTOMER ORDER NUMBER		JOB/RELEASE NUMBER		OUTSIDE SALESPERSON	
128681						Gregory T Blankenshi	
INSIDE SALESPERSON		REQD DATE		FRIGHT ALLWD		SHIP VIA	
Todd E Horto		02/19/19		No			
ORDER QTY	SHIP QTY	LINE	DESCRIPTION	Prc/UM	Ext Amt		
50EA		14	*HELI HG-210-3/8 DEADEND GUY GRIP	2.600EA	130.00		
1EA		15	*CEMO 70380343 CM WILDLIFE BIRDCUARD	4.250EA	4.25		
25EA		16	*ELEM 707YTIE 8' YELLOW GUY GUARD	2.400EA	60.00		
50EA		17	MACL J6555 5/8 GUY ATTACHMENT MALLEABLE STEEL 50/BOX	4.750EA	237.50		
12EA		18	*POPR 366-S LOW VLG PINTYPE INSLT ANSI 55-4	390.000C	46.80		
50EA		19	*POHA P532G P53-2G POWER LINE	0.580EA	29.00		
18EA		20	*POHA P8215-S 15KV POLYMER SUSPENSION INSULATOR	8.950EA	161.10		
10EA		21	MACL GCC15-60R2 GUY STRAIN INSULATOR 15000# 60" LONG WITH ROLLER ON EACH END	27.500EA	275.00		
50EA		22	*PEUN GSE-C1-TN TRANSFORMER GROUNDING LUG; TIN PLATED	1.900EA	95.00		
1EA		23	*GE 5501AB0010 GE 10KVA 2-BUSH CON TRANSFORMER 7200/12470Y - 120/240 VOLTS	556.000EA	556.00		
885LB		24	COND ACSR 1/0 RAVEN 885LB REEL  885LBS = 6095FT	175.000C	1548.75		
15EA		25	MACL J740Z PIN PT W/NA THD	8.250EA	123.75		
2EA		26	MACL D75D 3/4X7 TWINEYE ANCHOR ROD	22.500EA	45.00		
4EA		27	GALV 6258 5/8X8 CU CTD GND ROD	11.750EA	47.00		
200EA		28	MACL J8754TP 1/2X4 LAG SCREW TWIST DRIVE, DRIVE POINT	0.690EA	138.00		
*** Continued on			Next Page ***				



**Quotation**

**STUART C IRBY RR743 KENNESAW  
1025-A COBB INTERNATIONAL PLACE  
SUITE A  
KENNESAW GA 30152  
770-422-1005 Fax 770-427-8455**

QUOTE DATE	ORDER NUMBER
02/19/19	S011238137
REMIT TO: STUART C IRBY CO POST OFFICE BOX 741001 ATLANTA GA 30384	PAGE NO.  3

**SOLD TO:  
CITY OF OXFORD  
110 W. CLARK STREET  
OXFORD, GA 30054-2274**

**SHIP TO:  
CITY OF OXFORD  
110 W. CLARK STREET  
OXFORD, GA 30054-2274  
770-786-7004**

**ORDERED BY:**

CUSTOMER NUMBER		CUSTOMER ORDER NUMBER		JOB/RELEASE NUMBER		OUTSIDE SALESPERSON	
128681						Gregory T Blankenshi	
INSIDE SALESPERSON		REQD DATE		FRIGHT ALLIND		SHIP VIA	
Todd E Horto		02/19/19		No			
ORDER QTY	SHIP QTY	LINE	DESCRIPTION	Prc/UOM	Ext Amt		
50EA		29	MACL HLS-2/0 HL STIRRUP	11.250EA	562.50		
50EA		30	*HELI HSPT-022 SPOOL TIE FOR 1/0 6/1 ACSR	3.750EA	187.50		
25EA		31	MACL D6562A ANCHOR EYENUT POWER SCREW	8.750EA	218.75		
25LB		32	UTBC 6 SD BARE SOL 25LB SPOOL	450.000C	112.50		
250FT		33	COND 6 SD POLY RISER SOL TRANS 250FT	540.000M	135.00		
50EA		34	MACL CW-44-6 4X4 CURV WASHER	2.800EA	140.00		
200EA		35	MACL J1075 3/16X2-1/4 SQ WASHER 11/16 HOLE	0.300EA	60.00		

**\* This is a quotation \***

Prices firm for acceptance within 30 days with the exception of commodity prices which are subject to change daily. Quotation is void if changed. Complete quote must be used unless authorized in writing.

For Terms and Conditions, Please See our website.

<b>Subtotal</b>	<b>7047.15</b>
<b>S&amp;E CHGS</b>	<b>0.00</b>
<b>Sales Tax</b>	<b>0.00</b>
<b>TOTAL</b>	<b>7047.15</b>

**\*\* Reprint \*\* Reprint \*\* Reprint \*\***



**Quotation**

STUART C IRBY BR743 KENNESAW  
 1025-A COBB INTERNATIONAL PLACE  
 SUITE A  
 KENNESAW GA 30152  
 770-422-1005 Fax 770-427-8455

QUOTE DATE	ORDER NUMBER
02/19/19	S011238108
REMIT TO:	PAGE NO.
STUART C IRBY CO POST OFFICE BOX 741001 ATLANTA GA 30384	I

SOLD TO:  
 CITY OF OXFORD  
 110 W. CLARK STREET  
 OXFORD, GA 30054-2274

SHIP TO:  
 CITY OF OXFORD  
 110 W. CLARK STREET  
 OXFORD, GA 30054-2274  
 770-786-7004

ORDERED BY:

CUSTOMER NUMBER	CUSTOMER ORDER NUMBER	JOB/RELEASE NUMBER	OUTSIDE SALESPERSON		
128681			Gregory T Blankenshi		
INSIDE SALESPERSON	REQD DATE	FRIGHT ALLWD	SHIP VIA		
Todd E Horto	02/19/19	No			
ORDER QTY	SHIP QTY	LINE	DESCRIPTION	Prc/UOM	Ext Amt
			***** Shipping Instructions *****		
			* ESTIMATE# 684 OXFORD WEST CLARK ST	*	
			* LEAD TIME = STOCK-12WKS	*	
			*****		
20EA		1	MACL HDSO47 HOT LINE DEADEND CLAMP AL SIDE OPENING .19 -.47" #6-2/0 ACSR	11.200EA	224.00
750FT		2	GUY 3/8 UG CLS-A 250' COIL A475	320.000M	240.00
12EA		3	MACL D104-6 10" HELIX ANCHOR FOR 3/4 -1" ROD STANDARD DUTY 6000# TORQUE RATING	24.250EA	291.00
50EA		4	MACL J8812 5/8X12 MACHINE BOLT	1.220EA	61.00
4EA		5	MACL ZHP010-0000000 10KV SRG ARST	34.750EA	139.00
25EA		6	*POHA P9410 5/8 X 10 OVAL EYE BOLT	2.400EA	60.00
25EA		7	*POHA P9412 5/8 X 12 OVAL EYE BOLT	2.500EA	62.50
100EA		8	*POHA P8812 5/8 X 12 MACHINE BOLT HO	1.150EA	115.00
4EA		9	*SFRM SF-12L SINGLE PHASE 25KV ARRESTER/CUTOUT T-BRACKET	14.950EA	59.80
24EA		10	*POHA P1300 DEAD END CEVIS HOT DIP G	3.500EA	84.00
25EA		11	BLAC HLC2108 HOT LINE CLAMP	7.400EA	185.00
4EA		12	*POHA SIL115-195-PN 15KVA CUTOUT WITH PARALLEL GROVE CLAMP AND NEMA BRKT	61.750EA	247.00
50EA		13	*HELI HD-522 DEADEND DIST GRIP	2.250EA	112.50
50EA		14	*HELI HG-210-3/8 DEADEND GUY GRIP	2.600EA	130.00
***	Continued	on	Next Page ***		



Quotation

STUART C IRBY BR743 KENNESAW  
 1025-A COBB INTERNATIONAL PLACE  
 SUITE A  
 KENNESAW GA 30152  
 770-422-1005 Fax 770-427-8455

QUOTE DATE	ORDER NUMBER
02/19/19	5011238108
REMIT TO: STUART C IRBY CO POST OFFICE BOX 741001 ATLANTA GA 30384	PAGE NO.  2

SOLD TO:  
 CITY OF OXFORD  
 110 W. CLARK STREET  
 OXFORD, GA 30054-2274

SHIP TO:  
 CITY OF OXFORD  
 110 W. CLARK STREET  
 OXFORD, GA 30054-2274  
 770-786-7004

ORDERED BY:

CUSTOMER NUMBER		CUSTOMER ORDER NUMBER		JOB/RELEASE NUMBER		OUTSIDE SALESPERSON	
128681						Gregory T Blankenshi	
INSIDE SALESPERSON		REQD DATE		FREIGHT ALLMD		SHIP VIA	
Todd E Horto		02/19/19		No			
ORDER QTY	SHIP QTY	LINE	DESCRIPTION		Prc/UOM	Ext Amt	
2EA		15	*DCDD 00800-098 SUPPORT GRIP FOR 1.00-1.24" CABLE		28.750EA	57.50	
2EA		16	*CEMO 70380343 CM WILDLIFE BIRDCUARD		4.250EA	8.50	
25EA		17	*ELEM 707YTIE 8' YELLOW GUY GUARD		2.400EA	60.00	
50EA		18	MACL J6555 5/8 GUY ATTACHMENT MALLEABLE STEEL 50/BOX		4.750EA	237.50	
12EA		19	*POPR 366-S LOW VLG PINTYPE INSLT ANSI 55-4		390.000C	46.80	
50EA		20	*POHA P532G P53-2G POWER LINE		0.580EA	29.00	
18EA		21	*POHA P8215-S 15KV POLYMER SUSPENSION INSULATOR		8.950EA	161.10	
20EA		22	MACL GCC1578R2 CLEVIS W/2 ROLLERS		27.650EA	553.00	
200EA		23	MACL J3316P 4-3/4 DRIVE HOOK		0.850EA	170.00	
50EA		24	*PEUN GSE-C1-TN TRANSFORMER GROUNDING LUG; TIN PLATED		1.900EA	95.00	
1EA		25	*GE QAMW754 (5501AB0015) 15KVA XFM 1PH CONV POLE-MT HV: 7200/12470Y LV: 120/240 2-BUSH		582.000EA	582.00	
2EA		26	*GE QAMW755 (5501AB0025) 25KVA XFM CONV POLE-MT HV: 7200/12470Y LV: 120/240 2-BUSH		712.000EA	1424.00	
15EA		27	MACL J740Z PIN PT W/NA THD		8.250EA	123.75	
7EA		28	MACL D75D 3/4X7 TWINEYE ANCHOR ROD		22.500EA	157.50	
200EA		29	MACL J8754TP 1/2X4 LAG SCREW TWIST DRIVE, DRIVE POINT		0.690EA	138.00	
20EA		30	BLAC SCO21 COMP STIRRUP		7.750EA	155.00	
*** Continued		on	Next Page ***				



**Quotation**

STUART C IRBY BR743 KENNESAW  
 1025-A COBB INTERNATIONAL PLACE  
 SUITE A  
 KENNESAW GA 30152  
 770-422-1005 Fax 770-427-8455

QUOTE DATE	ORDER NUMBER
02/19/19	S011238108
REMIT TO: STUART C IRBY CO POST OFFICE BOX 741001 ATLANTA GA 30384	PAGE NO.  3

SOLD TO:  
 CITY OF OXFORD  
 110 W. CLARK STREET  
 OXFORD, GA 30054-2274

SHIP TO:  
 CITY OF OXFORD  
 110 W. CLARK STREET  
 OXFORD, GA 30054-2274  
 770-786-7004

ORDERED BY:

CUSTOMER NUMBER		CUSTOMER ORDER NUMBER		JOB/RELEASE NUMBER		OUTSIDE SALESPERSON	
128681						Gregory T Blankenshi	
INSIDE SALESPERSON				REQD DATE	FRGHT ALLND	SHIP VIA	
Todd E Horto				02/19/19	No		
ORDER QTY	SHIP QTY	LINE	DESCRIPTION	Prc/UOM	Ext Amt		
25EA		31	MACL D6562A ANCHOR EYENUT POWER SCREW	8.750EA	218.75		
10LN		32	*ELEM PE2UG10ST U-GUARD 2" X 10FT HDPE (1500' PER PALLET) (PRICE PER LENGTH) (ALT UOM PER FT) (1LN=10FT) (1EA=1 LENGTH)	9.250LN	92.50		
250FT		33	COND 6 SD POLY RISER SOL TRANS 250FT	540.000M	135.00		
50EA		34	MACL CW-44-6 4X4 CURV WASHER	2.800EA	140.00		
200EA		35	MACL J1075 3/16X2-1/4 SQ WASHER 11/16 HOLE	0.300EA	60.00		

\* This is a quotation \*

Prices firm for acceptance within 30 days with the exception of commodity prices which are subject to change daily. Quotation is void if changed. Complete quote must be used unless authorized in writing.

For Terms and Conditions, Please See our website.

Subtotal	6655.70
S&H CHGS	0.00
Sales Tax	0.00
<b>TOTAL</b>	<b>6655.70</b>

\*\* Reprint \*\* Reprint \*\* Reprint \*\*